

ICS REPEATER CONTROLLERS

LINKER IIa USER MANUAL

INTEGRATED CONTROL SYSTEMS

1076 North Juniper Street
Coquille , OR 97423
Email support@ics-ctrl.com
Website www.ics-ctrl.com

Last updated 05/07/15
Linker IIa User Manual V1.26

TABLE OF CONTENTS

PAGE NO.

Table of contents	1
General Description of the ICS Linker IIa Repeater Controller	2 - 3
Special features for the Linker IIa	4 - 5
Command Structure	6
Remote Base Controller Feature	7 - 8
Quick connect for the control receiver	9
Quick connect for the repeater receiver	10
Specifications	11
Linker IIa board layout diagram	12
Jumper and Plug position diagram	13
Plug wiring diagrams	14
Function numerical list	15 - 17
Function descriptions	18 - 83
Programmable tones	84
Repeater control codes table – use to record your DTMF codes	85
Linker IIa schematic diagram	

General Description of the ICS Linker IIa Repeater Controller

Here at ICS we strive to make products that have new, innovative, easy to use features and excellent quality at a reasonable cost. We believe the Linker IIa is such a product. The Linker IIa has such innovative features such as remote base control, a full featured control receiver input (has priority), programming with actual values (i.e. Volts, Hertz, Seconds, wpm) and a very easy to use 3 level command access feature which has over 65 commands available. It also has microprocessor support for a CTCSS board, both encode and decode. There is a plug specifically for the CTCSS board. The CTCSS encode also has an encode hang timer in which the time is programmable. When designing the Linker IIa we worked hard to provide a product that is easy to use, durable and of excellent quality at a reasonable cost.

The Linker IIa has many unique features. One such feature is the control receiver input. This input is unique in that it provides a level of control normally only provided on more expensive controllers. It is optional to use the Control receiver input as the repeater receiver input (port 1) and even the link / remote base receiver input (port 2) will provide the access to control the repeater. The control receiver gives you control over the repeater even if the repeater's receiver is inaccessible. Also, with the addition of a resistor, you can pass the control receiver audio to the repeaters transmitter audio output (port 1) and the audio level can be adjusted with the control receiver input audio pot. The control receiver COS can be set to switch between 1 and 9 volts and the polarity can be easily set as well. When the control receiver COS becomes active all the port 1 and Port 2 DTMF signals are ignored and the Linker IIa only listens to the control receiver for DTMF codes. The repeater (Port 1) input has priority over the remote base / link receiver (Port 2). This allows for priority control with the control receiver.

Another such unique feature is the remote base control system, which will allow you to use most radios that have memories and that have a mike input for UP memory. You simply program in the frequencies, the offsets and the CTCSS tones (encode and decode) into your radio's memory and tell the Linker IIa how many memories you have on your radio to increment through. The Linker IIa remembers which memory the remote base is set too even if the power is turned off. All the user needs to do is select which memory he wants with a DTMF command. When the remote base radio is disabled or turned off the Linker IIa will return the radio to the home memory. When desired you may select from one of 6 link / remote base commands to control your link / remote base radio. These commands are easy to use and give you an easy to use multi frequency remote base at a reasonable cost.

The new Linker IIa CTCSS control feature gives a wide range of control over CTCSS decode and encode signals. The Linker IIa gives you DTMF on and off control over CTCSS decode, encode and the encode hang timer. Also the CTCSS encode hang timer is programmable. The encode hang timer starts from the time the repeater receiver becomes non-active. This will allow a reverse burst or courtesy tone to be heard after the receiver becomes inactive.

The ever growing set of easy to use features can be accessed by a secure Setup mode (program mode), a Control operator mode and a User mode. If desired the Setup mode (program mode) can be accessed only by a hardware jumper from the factory. A DTMF sequence (up to 10 digits) can be programmed to give access to the Setup mode if desired. This provides the highest level of security. In the Setup mode (program mode) all the commands are accessible by DTMF using their 2 or 3 digit command / function codes. This makes the controller programming easy. The User and Control operator levels use from 1 to 5 digits to access these same functions if setup to do so. From 0 to 25 DTMF codes can be setup for the User and Control operator levels allowing easy programming, total flexibility and an extremely secure system for controlling the Linker IIa and its functions.

It can be difficult at times to work on a repeater without knowing what the incoming and outgoing signals are doing. Connecting voltmeters, scopes and other monitoring equipment can sometimes be difficult. We have provided many LEDs to help make the setup of the repeater easier. The Linker IIa has 9 of them. Most of the input and output signals are indicated. The controller will also indicate when it recognizes a DTMF code. When not being used the LEDs can be disabled with a jumper. We have found these indicators to be a big help when working with repeaters.

The control inputs and outputs of the Linker IIa repeater controller are very simple to use. There are 3 COS inputs, 2 CTCSS inputs and 4 open collector type outputs. The inputs include a Control receiver COS input, the repeater input (port 1) with COS and CTCSS inputs, and the remote base / link receiver (port 2) also has a COS and a CTCSS input. All of these COS and CTCSS inputs can be set to switch between 1 and 9 volts and the polarities are programmable. Both ports 1 and 2 have COS and CTCSS inputs. You may select between the COS and CTCSS or select both for 'AND' or 'OR' control. This allows for the switching back and forth between carrier squelch and CTCSS (need an external CTCSS board (TS-64)) for the 'receiver active' signal.

The auxiliary outputs of the Linker IIa are multi featured and easy to use. The 3 auxiliary outputs can be used for several different functions. All of the 3 auxiliary outputs can send a short pulse or either be locked on or off. The Auxiliary 1 output has a programmable timer that can be enabled or disabled. It can also control a timed transmitter fan. The Auxiliary 2 output optionally provides the PTT for the link / remote base transmitter (port 2). The Auxiliary 3 output can provide control of the remote base memory selection. The 4th open collector output is for the repeater / port 1 push to talk. All of the inputs are buffered and the outputs are protected to greatly reduce any chance of damage.

SPECIAL FEATURES OF THE ICS LINKER IIa

CTCSS Encode / Decode Control

A very powerful feature of the Linker IIa is the support for the CSI TS-64 CTCSS encode / decode board for port 1. Although this feature was designed with the CSI TS-64 board in mind it will work with many others as well. This feature includes a separate plug to support the CSI TS-64 CTCSS board, CTCSS decode enable, CTCSS encode and an encode hang timer for port 1. The CTCSS encode signal is mixed in with the repeater transmit audio. For more information on this feature see the section on the CTCSS encode / decode control.

The Linker IIa gives you the option of having receiver 1 or receiver 2 (or both) enable transmitter 1 encode. The Linker IIa has commands to enable and disable these functions. The commands are Enable RX 1 CTCSS encode activate (function #110), Disable RX 1 CTCSS encode activate (function #111), Enable RX 1 CTCSS encode activate (function #112), Disable RX 2 CTCSS encode activate (function #113).

Port 2 modes

Some other features special that the Linker IIa has are xpeat mode, slave repeater mode and full duplex mode on the 2ad port (Link / Remote base port). The xpeat is designed to activate transmitter 1 when receiver 2 becomes active and transmitter 2 when receiver 1 is active. Receiver 1 will have priority.

The slave repeater mode on the ICS Linker IIa will allow two repeaters to be run on one controller. As the Linker IIa has one IDer both repeaters will be IDed at the same time. The IDer will still try not to ID over any conversation on either repeater.

The full duplex mode on the ICS Linker IIa allows full duplex operation on port 2. Both receivers and both transmitters can be on at the same time and the audio from both receivers will be mixed together.

The Linker IIa now has a function to report what the remote base radio is set to (function #129). The controller will report in morse code what memory the remote base is set to.

Beacon Mode

The Linker IIa now has Beacon mode. When the Linker IIa is in Beacon mode it will send the ID when the IDer pending ID timer times out (see function #68). The polite ID timer will still operate holding off the ID until the polite ID timer times out or until the receiver becomes nonactive.

Programmable Tones

Another new feature for the Linker IIa is programmable tones. There are currently 5 programmable tones and 40 different tones available to put in the each of the programmable tones. The 5 programmable tones are as follows;

1. Port 1 programmable tone
2. Port 2 programmable tone
3. Setup mode programmable tone
4. Change memory programmable tone
5. Port 1 programmable tone when port 2 is active

See Function #127 for further details. The available programmable tones and the available tones are at the end of the manual, you can find the page number in the table of contents.

Antikerchunker Filter

The Linker IIa's antikerchunker filter will help eliminate the kerchunking of your repeater. The operation is simple, when the antikerchunker filter is enabled (see the Enable antikerchunker filter (command #118) and the Disable antikerchunker filter (command #119)) and Linker IIa sees that the repeater receiver is active the Linker IIa will wait a programmed period of time (see the Set antikerchunker filter delay (command #120)) before it recognizes the repeater receiver as active. If the repeater receiver stays active for the preprogrammed period of time the Linker IIa will then recognize the repeater receiver as being active. Once the Linker IIa recognizes the repeater receiver is active the Linker IIa will temporarily disable the antikerchunker filter for a preprogrammed period of time (see the Set antikerchunker filter interval time (command #121)).

Hardware Reset Jumper (NEW)

The reset jumper is meant to allow the Linker IIa to be set back to the factory parameters. With the use of the reset jumper the "Set parameters to factory default" (function #66) will be activated. The reset jumper is located on the top of the controller board and is marked "RESET".

To use the reset jumper to reset the controller to the factory default first power down the controller. Put both the Setup mode jumper and reset jumpers in place. Once these jumpers are in place power up the controller.

The DV LED will flash for 15 seconds. This is a warning that a controller reset to factory defaults is about to occur. Removal of either the reset jumper or the Setup mode jumper will stop the DV LED from flashing and cancel the controller reset.

After the 15 seconds are completed the controller will reset itself. The controller will do a warm start and if the Setup mode and reset jumpers are still in place the DV LED will again start flashing. This is because both jumpers are in place and the controller software is starting from fresh.

There will be a noticeable delay between the series of LED flashing. When the DV LED begins to flash again is the best time to power down the controller. Once the controller is powered down remove the reset jumper, power up and the controller will operate normally with the factory defaults in place.

COMMAND STRUCTURE

The command structure of the Linker IIa is easy to use and very versatile. It includes a Setup mode for programming and 2 levels for control. The two levels are the Control operator mode and User mode. The structure of these levels gives needed security and still provides a very easy system to setup and program. The Setup mode gives you direct access to all the functions directly. In Setup mode the function codes are entered directly with your DTMF pad. The Control op and User modes are very similar to each other. To access a command in either of these modes you need to have programmed (from Setup mode) a DTMF sequence (1 to 5 DTMF digits) followed by the function in a DTMF memory. When you enter the DTMF codes in Control op or User mode that are in a DTMF memory the command in the DTMF memory will be called. A condition code can be added to the DTMF memory to restrict that DTMF memory (and its command) to the Control op mode only, the command will then not be accessible in the User mode.

The Setup mode (program mode) allows access to all the functions. All the functions can be activated just by entering the 2 or 3 digit code for that function. When the Linker IIa controller leaves the factory the only way to access the Setup mode is with the hardware jumper. It initially can not be accessed any other way. Normally if the Setup mode jumper is in you are in Setup mode and if it is not in you are not in Setup mode. There are two functions that can be used to enter and exit the Setup mode remotely, 'Exit Setup mode' (see function #59) and 'Enter Setup mode' (see function #58). The Setup mode can be accessed by putting the 'Enter Setup mode' function in the Control op or User modes using a DTMF command memory (see function #78). The 1 to 5 digits you program in will give you access to the Setup mode. If you only allow access to the DTMF code for the Setup mode in Control op mode the Linker IIa can be setup to require up to 10 digits to access the Setup mode, 5 digits to go from the User mode to the Control op mode and 5 digits to access the DTMF memory you programmed the "Enter Setup" command into. Remote access to the Setup mode is only available if you make it so.

When the Linker IIa is in the Setup mode (program mode) the Linker IIa uses a special courtesy tone. The courtesy tone is 3 dits or a Morse code "S" to indicate being in Setup mode. If the repeater is left in the Setup mode and the repeater can not be physically accessed to remove the Setup jumper the Setup mode can be exited using the 2 digit 'Exit Setup mode' function. This is true even if the Setup jumper is still installed.

The Control op mode is intended to give access to control functions that only a few people should have. In the Control op mode all the preprogrammed DTMF memories are available. In the User mode you can provide limited access to the DTMF memories. Only the DTMF memories that have not been setup as Control op level, will be accessible in User mode. Any, some or none of the Linker IIa's commands can be enabled on this level. You program any of the functions you want to give access to and on what level.

To give access to a function in the Control Operator or User modes a DTMF code and a function must be entered in a DTMF memory. You must be in Setup mode to program a DTMF memory. To start the entry use the "ENTER DTMF COMMAND LINE" function (#78). First you select a DTMF memory 0 – 24, then enter to 5 DTMF code digits, then indicate if this DTMF memory is to be only available in the Control op level and of course the function you wish to give access to (see the ENTER DTMF COMMAND LINE (#78) function in the function descriptions). All 16 DTMF digits can be used in a DTMF code including A, B, C, D, * and #. An example of the DTMF code layout for a few DTMF memories is shown below;

DTMF Memory number	DTMF codes, 1 to 5 digits	Control Op?	function
0	2 # 0	N	33 (DISABLE TX 1)
1	2 # 1	Y	32 (ENABLE TX 1)
2	3 9 0 B #	N	60 (SET CONTROL OPERATOR MODE)
3	C	Y	61 (CLEAR CONTROL OPERATOR MODE)
4	A # 4 B 2	Y	58 (ENTER SETUP MODE)
5	B	N	48 (ACTIVATE KEYPAD TEST)

Any of the functions can be used in a DTMF memory. There is a chart at the end of this manual that is similar to the above and can be copied and used to keep track of your DTMF settings. Note: The Linker IIa controller comes with all DTMF memories empty, you must use Setup mode (program mode) initially for access to the Linker IIa's functions.

LINKER II / LINKER IIa REMOTE BASE CONTROLLER

The remote base controller on the Linker IIa uses a new and unique method to control a remote base. Most radios that have an up input on the microphone that can be used. The Linker IIa controller will allow you to select from any one of the preset memories in the remote base radio's memory. The Linker IIa supports from 1 to 250 memories. The Linker IIa remembers what memory the remote base radio is set to. The user only needs to select which memory he wants to use and the Linker IIa will automatically select that memory on the remote base. This is a very easy way of selecting remote base memories as the frequencies, offsets and CTCSS – DCS settings are all preset in the remote base radio. You can choose to only have the receiver active, to have the receiver and transmitter active or even only the transmitter active on the remote base radio. The commands are easy to setup and to use.

The connection from the remote base radio to the Linker IIa controller is straightforward. First you will need to determine a way to get a COS signal from your remote base radio. The Linker IIa's RX 2 COS input can read voltages from 1 to 9 volts with a positive or negative polarity. While the RX 2 COS input will read from 1 to 9 volts you can apply a voltage of 0 to 40 volts to it. The COS signal also needs to be able to operate with the Linker IIa's approximate input impedance of 100K. The Linker IIa's COS inputs are preprogrammed to be positive acting and the CTCSS inputs are also preprogrammed to be positive acting. The COS and CTCSS inputs will both switch at about 2.5v from the factory. IF (and only if) you need to change the polarity or the switching voltages the Linker IIa will allow you to do that without adding external circuitry. Please see the SET RX 1 VOLTAGE (Function #79 and #80) for the repeater inputs (port 1) and the SET RX 2 COS VOLTAGE (Function #81 and #82) for the remote base / link (port 2) inputs. You might also want to look at the quick setup guide for the repeater receiver (see index).

The next connection that needs to be made is the remote base / link receiver (port 2) audio. This is fairly simple. If you are using a regular radio (such as a mobile rig) as a remote base first you should use a resistor that has an equivalent resistance with a sufficient power rating as the radio's speaker, as this is the output impedance the radio's speaker output was designed for. This resistor should be tied from the audio output to ground. Keep the radio's volume as low as possible. You will not need much audio. The audio signal for the RX 2 input on the Linker IIa can be taken from the signal or non ground side of this resistor. There are other ways to get an audio signal but this is one easy way to get remote base / link audio. You may also use discriminator audio. The audio from the discriminator can give you much better sounding audio.

The mike input of the remote base / link radio is the typical connection to the Linker IIa's TX 2 audio. You may want to add a resistor (typically 47k) in series with the mike input to match the low output impedance of the Linker IIa's RX 2 audio output to a high impedance microphone input of a remote base / link radio's microphone input.

If your radio has an "UP" input on its microphone input this can be used to give the Linker IIa control over which memory to select. The auxiliary 3 output of the Linker IIa is used for this purpose. The "UP" input can be connected directly to the auxiliary 3 input if the "UP" input is designed to go to ground for its activation. The Linker IIa uses an open collector configuration for this function. If the "UP" input on the remote base radio does not normally get switched to ground to select the next memory a relay may be connected to the auxiliary 3 output and appropriate connections to the radio made on the other side of the relay. This is all that is necessary to wire up the memory selection of your remote base.

The auxiliary 3 output has a programmable timer (see function #116) which times how fast the auxiliary 3 output goes on and off. This timer can be set to speed up or slow down the rate in which the remote base memories are selected.

The Linker IIa uses a "home memory" as a reference point. This is the memory in the remote base radio the Linker IIa will consider memory number 0. The Linker IIa will always return the remote base radio to the home memory when the remote base is disabled. Memory '0' will always be the first memory to the Linker IIa. The current memory number is stored in the Linker IIa's EEPROM memory so the Linker IIa will remember the currently selected memory the remote base is set to even if the power goes out.

The Linker IIa will always increment the remote base memory up, even when returning to the home memory or to go to one memory below the current memory. The Linker IIa will “wrap around” memories. When the radio’s highest memory is reached the Linker IIa will expect the next UP signal to bring the radio to the first or lowest memory. While the memories are changing (or while any function is active) TX 1 will remain on. When TX 1 drops you will know the memory changing has been completed. The Linker IIa will send a cover tone while the remote base memories are being selected.

Once all the connections are made and the COS input voltages (you probably don’t need to change these) are set you will need to program the remote base radio itself. Once this is done the Linker IIa will need to know how many memories it will have to increment through. This means the actual number of memories that show up on the display of the remote base radio, even if they are not used. This is done using the “SET NUMBER OF REMOTE BASE MEMORIES “ function (Function #71). The Linker IIa’s remote base memory numbers start at 0 so the first memory is always memory number 0 (Home memory). Some radios start at memory 0 and some start at memory 1. The number the Linker IIa needs programmed in for the number of memories it will have to increment through.

TX 2 will go off if any DTMF tones are recognized on any receiver input. When doing control functions in most cases it is desirable to not be transmitting on the remote base’s transmitter as the remote base may be on a repeater’s input or frequency that is being used by others.

QUICK CONNECT FOR THE CONTROL RECEIVER

NOTE: *You do not need to use this input, it is optional, it is only for use with a separate control receiver. If you do not plan to use a separate control receiver then please skip this page. The repeater receiver port has access to all the same control functions (the control receiver has priority). Do not connect the repeater receiver to this input.*

1. ***If you decide to use a control receiver*** you should have the control receiver COS and audio signal already wired to the proper connections according to the plug layout in this manual before you start. These signals should be suitable to drive a 100K ohm load. ***It is not necessary to use a control receiver to operate the Linker IIa repeater controller.***
2. Make sure the repeater's transmitter is disconnected or disabled
3. Check to see what the COS on and off voltages are and write them down. The difference between them should be at least 1V and can be somewhat less if the COS voltages are very stable. If a battery is being used to power the Linker IIa or the receiver, the COS voltages that occur during battery discharge should also be taken into consideration. In the case of a discharging battery the voltage output from R16 will eventually change as the battery voltage goes below 10vdc.
4. ***Turn the power off.*** The control receiver audio input amplifier jumper JP2 setting needs to be determined. For high gain (about 10 times) do not install the jumper. For a low / normal gain (about 2 times) jump pins 2 & 3. To de-emphasize the audio (discriminator audio) jump pins 1 & 2.
5. If the COS goes positive when activated make sure the jumpers in JP5 have their skinny parts both faced towards U2. This is the position for a positive going COS polarity. From the factory the jumpers are set for a positive polarity (NOTE: Turn the jumpers in JP5 90 degrees for the opposite COS polarity)
6. If your COS is negative acting make sure the jumpers in JP5 are set so that one jumper has its long side facing U2. This is the jumper position for a negative going COS polarity.
7. If the Linker IIa's control receiver COS input is setup for a positive COS monitor the voltage on pin 12 of U2, if the Linker IIa's control receiver is setup for a negative COS monitor the voltage on pin 13 of U2
8. Adjust R54 (CONTROL RX COS LEVEL POT) until the voltage reading is in the middle of the measured COS voltage from step 3.
9. If you have a scope available, monitor the signal on U2 pin 7, if not skip to step 11.
10. Send a DTMF digit through the control receiver. Set R16 (CONTROL RX AUDIO) until you get about a 200mV reading. You should now see the VALID DTMF LED steadily lit up (no flickering).
11. If you do not have a scope available start by sending a DTMF digit tone through the control receiver.
12. Adjust R16 (CONTROL RX AUDIO) until you see the VALID DTMF LED light up. Try to find a center point so you are not on the edge of operation.
13. The control receiver should now be ready to perform control functions

QUICK CONNECT FOR THE REPEATER RECEIVER

This is a procedure that will help connect up the repeater's receiver. It is not the only way to do it but one that we have used that works well.

1. You should have a repeater receiver COS and audio signal already wired to the proper connections according to the plug layout in this manual before you start. These signals should be suitable to drive a 100K ohm load. The input amplifier jumper JP7 setting needs to be determined. For high gain (about 10 times) do not install the jumper. For a low gain (about 2 times) jumper pins 2 & 3. To de-emphasize the audio (for discriminator audio) jump pins 1 & 2.
2. The default trigger voltages for RX 1 and RX 2 are 2.4v off and 2.5V on. This results in a positive acting COS. These voltages can be reprogrammed if your COS signals are negative acting or need a different trigger point. If you have a positive acting COS and 2.5v is a good trigger point then please skip to step 11.
3. Make sure the repeater's transmitter is disconnected or disabled
4. Check to see what the COS on and off voltages are and write them down. The difference between them should be 1V or so but can be somewhat less if the COS voltages are very stable. If a battery is being used the COS voltages during battery discharge should also be taken into consideration when programming these settings. Write down the COS off voltage and the COS on voltage on a piece of paper.
5. Make sure the Linker IIa is in Setup mode (install the setup jumper JP4) and the following DTMF codes could be sent from the control receiver or you can use a jumper to +12v to activate the port 1 COS input. If you use a jumper then you would connect the 12v for 'COS active' and disconnect it for 'COS not active' when the COS input is set to factory default voltages.
6. You will need to enter in two voltage values that are in-between the two measured voltages in step 4. You may use three digits and the * as a decimal point. You would enter 2.34 Volts as 2*34 on your DTMF keypad.
7. For the repeater's (RX 1) COS on level setting activate the function SET RX 1 COS VOLTAGE ON LEVEL. Enter in a value that is at least 0.5v away from the measured COS off voltage. This voltage should be in-between the measured ON and OFF receiver COS voltages.
8. After completing the SET RX 1 COS VOLTAGE ON LEVEL function you may need to enter a second voltage value for the COS off setting. To set the repeater's COS off setting use the function SET RX 1 COS VOLTAGE OFF LEVEL and enter in a value at least 0.2v away from the measured COS on voltage. This voltage should be in-between the measured ON and OFF COS voltages.
9. Care should be taken when adjusting the repeaters audio in level with R66 (RX 1 AUDIO) so the DTMF decoder gets a signal which will allow a reliable decoding of any DTMF digits from the repeater's receiver
10. The repeater receiver COS and CTCSS input (Port 1) and the remote base / link (Port 2) COS and CTCSS inputs are set up in the same general way and this quick connect procedure can be used to setup the remote base / link COS and CTCSS inputs. The Port 2 COS and CTCSS
11. If you do not have a scope available start by sending a DTMF digit tone through the control receiver.
12. Adjust R66 (RX1 AUDIO LEVEL) until you see the VALID DTMF LED light up. Try to find a center point so you are not on the edge of operation.
13. The control receiver should now be ready to perform control functions

SPECIFICATIONS

SUPPLY VOLTAGE	13.8V	
IDLE CURRENT	@13.8V 29mA LEDs disabled	
MAXIMUM CURRENT TX 1 OUTPUT	1 A	
MAXIMUM CURRENT ON AUXILIARY 1 OUTPUT	1 A	
MAXIMUM CURRENT ON AUXILIARY 2 OUTPUT	1 A	
MAXIMUM CURRENT ON AUXILIARY 3 OUTPUT	1 A	
VOLTAGE IN ON RECEIVER 1 AUDIO INPUT	20mVpp to 10Vpp	
VOLTAGE IN ON RECEIVER 1 AUDIO INPUT	20mVpp to 9Vpp	
VOLTAGE IN ON RECEIVER 2 AUDIO INPUT	20mVpp to 9Vpp	
VOLTAGE IN ON THE CONTROL RECEIVER AUDIO INPUT	20mVpp to 9Vpp	
MAX VOLTAGE OUT ON RECEIVER 1 AUDIO OUTPUT	9Vpp	
MAX VOLTAGE OUT ON RECEIVER 2 AUDIO OUTPUT	9Vpp	
VOLTAGE IN ON THE RX 1 COS	0 to 30V	1 to 9V readable
VOLTAGE IN ON THE RX 2 COS	0 to 30V	1 to 9V readable
VOLTAGE IN ON THE CONTROL RX COS	0 to 30V	1 to 9V readable
VOLTAGE IN ON THE RX 1 CTCSS	0 to 30V	1 to 9V readable
VOLTAGE IN ON THE RX 2 CTCSS	0 to 30V	1 to 9V readable
OUTPUT IMPEDANCE FOR TRANSMITTER 1 AUDIO OUTPUT	< 300 ohms	
OUTPUT IMPEDANCE FOR TRANSMITTER 2 AUDIO OUTPUT	< 300 ohms	
INPUT IMPEDANCE ON RECEIVER 1 AUDIO INPUT	~100K ohms	
INPUT IMPEDANCE ON RECEIVER 2 AUDIO INPUT	~100K ohms	

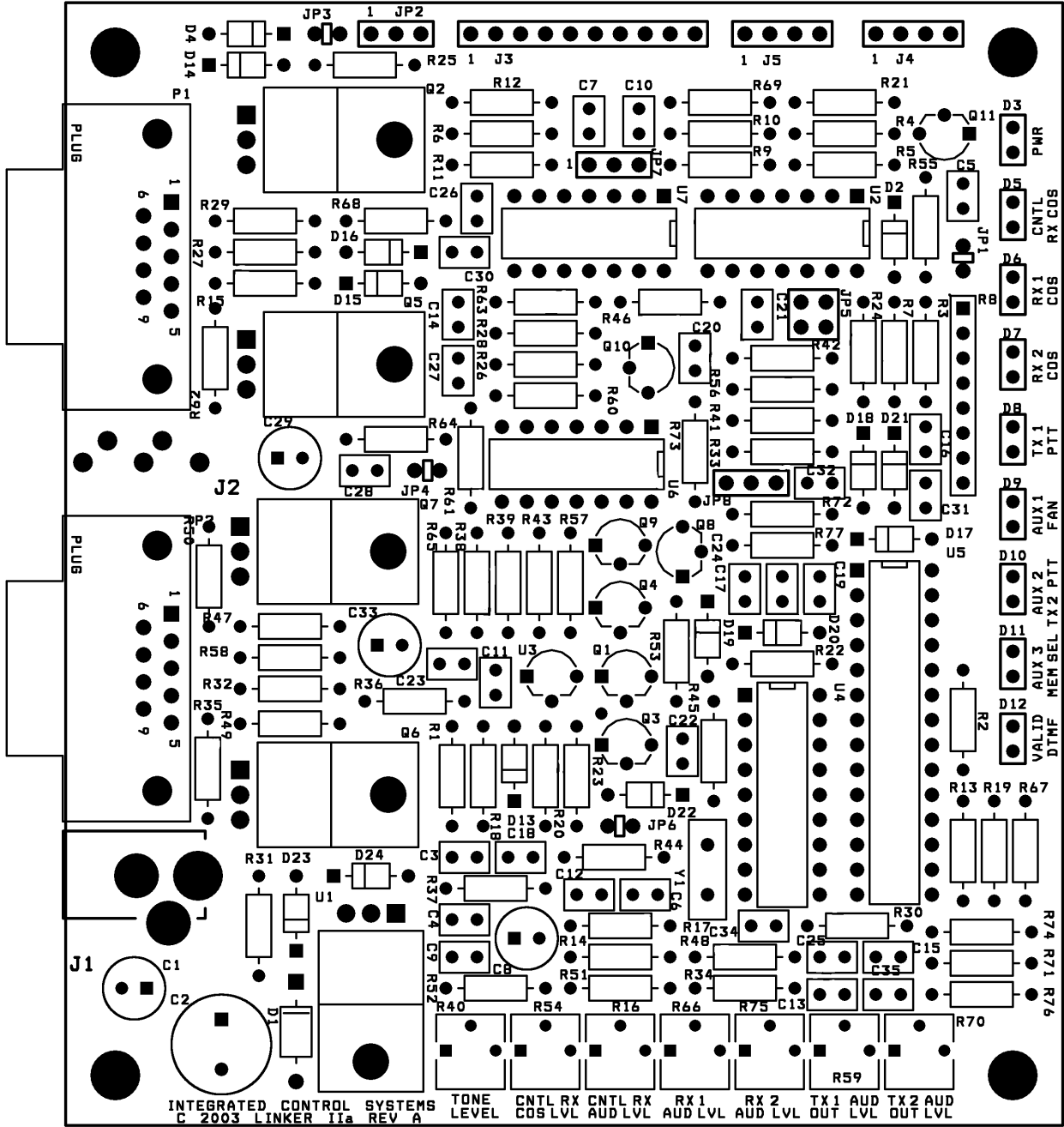

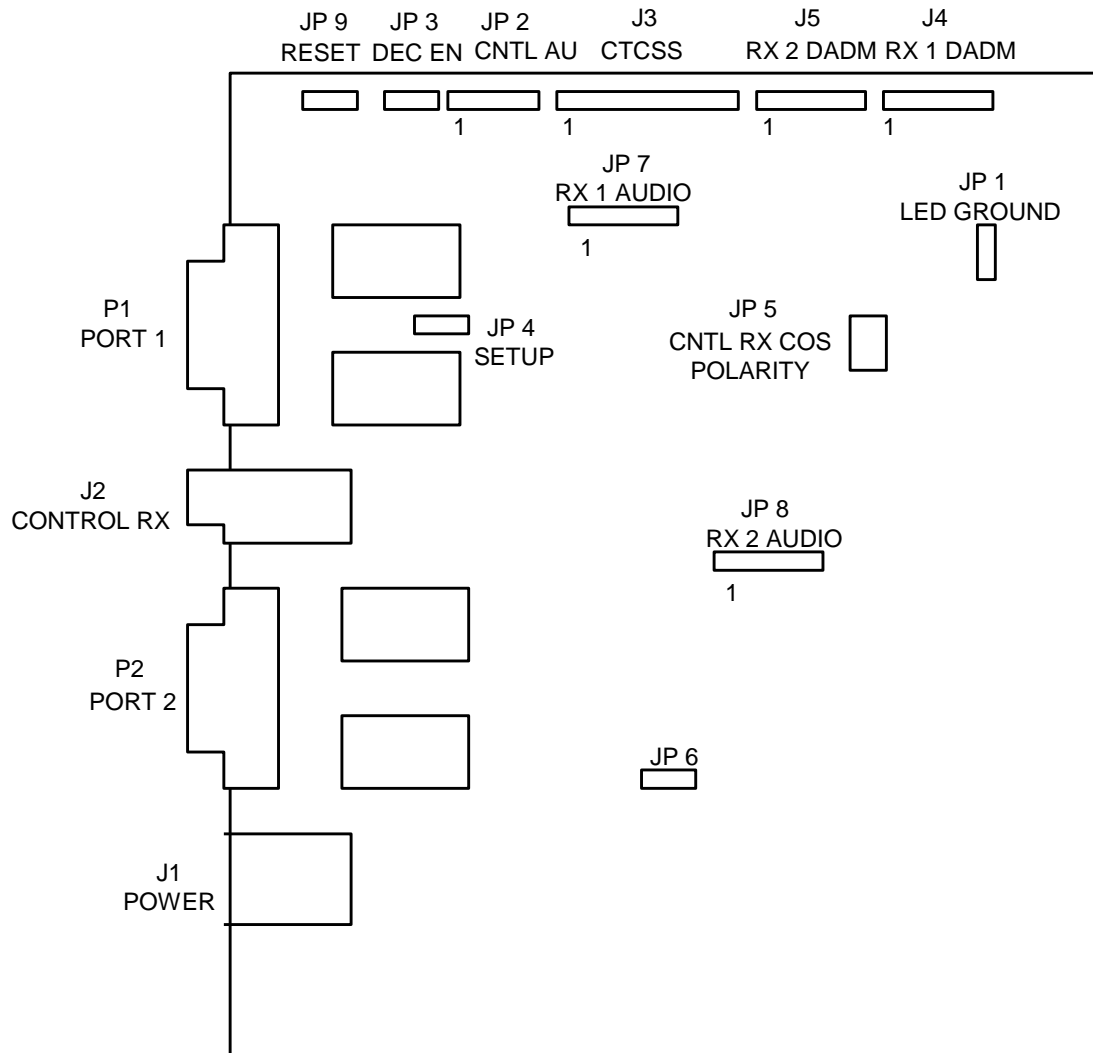

- J1 12V Power in, Center Positive, 2.5mm coaxial type jack
 J2 Control receiver COS and audio in
 J3 RX 1 CTCSS port, connections for 3rd party CTCSS board
 J4 RX 1 connection for ICS DADM board
 J5 RX 2 connection for ICS DADM board
- JP 1 LED ground - Remove this jumper to disable LED's
 JP 2 Control RX audio - 1 & 2 de-emphasized, 2 & 3 low gain (~2X), no jumper high gain (~10X)
 JP 3 RX 1 CTCSS Decode enable - Install jumper to enable 3rd party decoder
 JP 4 Setup mode jumper - install to put the controller in setup mode
 JP 5 Control RX COS polarity - Rotate both jumpers 90 degrees for opposite COS polarity
 JP 6 TX 2 tone enable - Enables courtesy tones and ID on TX 2 (Only for Slave repeater mode)
 JP 7 RX 1 audio - 1 & 2 de-emphasized, 2 & 3 low gain (~2X), no jumper high gain (~10X)
 JP 8 RX 2 audio - 1 & 2 de-emphasized, 2 & 3 low gain (~2X), no jumper high gain (~10X)
 JP 9 Controller reset - reset to factory defaults
- P1 Connector for Port 1 connections
 P2 Connector for Port 2 connections

CONNECTORS ON LINKER IIa BOARD

P1 PORT 1

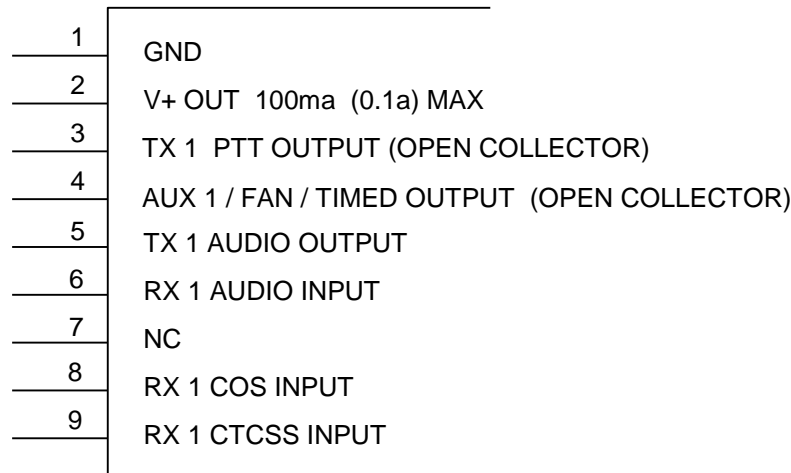

P2 PORT 2

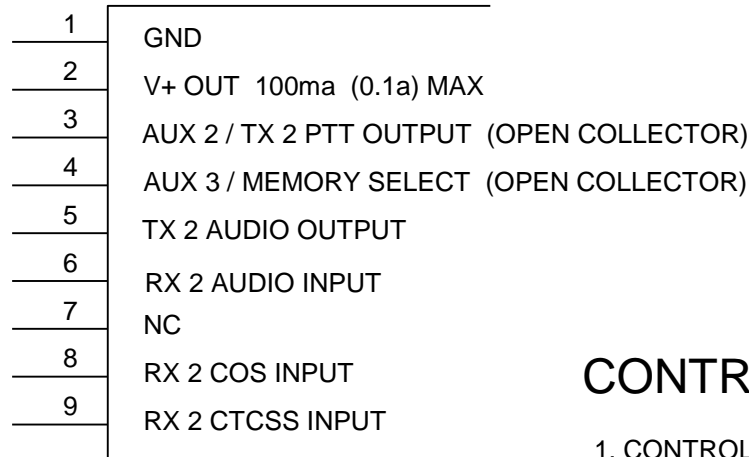

J2 CONTROL RX INPUT

1. CONTROL RX COS INPUT
2. CONTROL RX AUDIO INPUT
3. GND

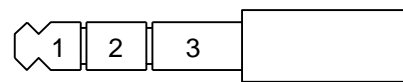

SHOWN IS THE JACK WHICH IS PLUGGED INTO THE LINKER IIa BOARD

J3 CTCSS PORT

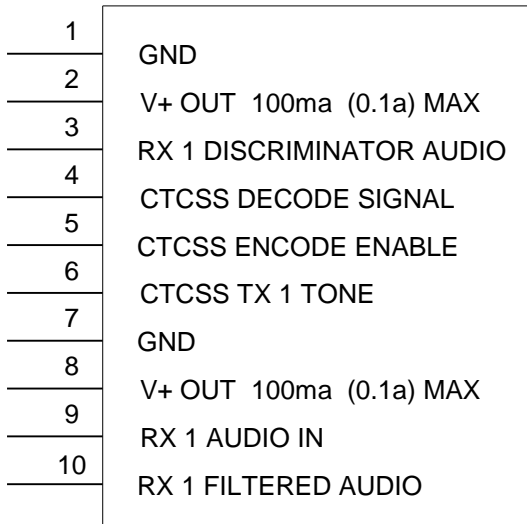

JUMP PINS 1 & 2 IF ICS DADM NOT USED

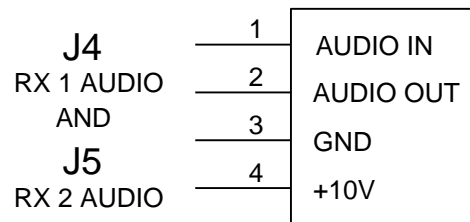

DO NOT USE +10V EXTERNALLY
CONTROLLER DAMAGE MAY OCCUR

FUNCTION LIST FOR THE ICS LINKER II / LINKER IIa CONTROLLERS

1. <u>Transmitter enable / disable functions</u>	
Enable TX 1	32
Disable TX 1	33
Force TX 1 on	85
Force TX 1 on clear	86
Enable TX 2	52
Disable TX 2	51
Disable RX 2 TX 1 and TX 2	146
Enable RX 2 TX 1 and TX 2	147
2. <u>Receiver enable / disable functions</u>	
Use only RX 1 COS input	35
Use only RX 1 CTCSS input	36
AND RX 1 COS and CTCSS inputs	93
RX 2 enable	50
RX 2 and TX 2 disable	49
Disable RX 2 TX 1 and TX 2	146
Enable RX 2 TX 1 and TX 2	147
Use only RX 2 COS input	96
Use only RX 2 CTCSS input	97
AND RX 2 COS and CTCSS inputs	98
Enable RX1	154
Disable RX1	155
3. <u>Auxiliary output functions</u>	
Turn auxiliary output 1 off	39
Turn auxiliary output 1 on	40
Turn auxiliary output 2 off	41
Turn auxiliary output 2 on	42
Turn auxiliary output 3 off	43
Turn auxiliary output 3 on	44
Pulse auxiliary 1 output	45
Pulse auxiliary 2 output	46
Pulse auxiliary 3 output	47
Set auxiliary 1 output timeout time	69
Turn auxiliary timer off	37
Turn auxiliary timer on	38
Enable timed TX fan on auxiliary 1 output	88
Disable timed TX fan on auxiliary 1 output	89
Set auxiliary 3 pulse time (pulse duration)	116
4. <u>DTMF command setup functions</u>	
Enter new DTMF command line	78
Clear all DTMF command lines	74
Clear one DTMF command line	75
Turn DTMF muting on	91
Turn DTMF muting off	92
Set RX2 DTMF control	99
TX1 off for DTMF disable	163
TX! off for DTMF disable	164

5.	<u>IDer commands / settings</u>	
	Force ID	34
	Enable IDer	62
	Disable IDer	63
	Set IDer polite ID time	67
	Set IDer pending	68
	Set word per minute rate	70
	Enter new ID	76
	Activate Beacon mode	114
	Deactivate Beacon mode	115
	ID cancel enable	134
	ID cancel disable	135
	TX2 ID with TX1 enable	136
	TX2 ID with TX1 disable	137
	No ID when port 2 enabled on	144
	No ID when port 2 enabled off	145
	Program ID delay timer	156
	TX1 on for ID delay	159
	TX1 off for ID delay	160
	TX2 on for ID delay	161
	TX2 off for ID delay	162
6.	<u>Tone control</u>	
	Courtesy tone enable	56
	Courtesy tone disable	57
	Turn on test tone	64
	Turn off test tone	65
	Set new cw frequency	77
	Set prebeep time	122
	Change a programmable tone	127
	Play a tone	128
	Set courtesy tone speed	133
	Enable RX1 tone RX2 active	142
	Disable RX1 tone RX2 active	143
7.	<u>System control functions</u>	
	Warm reset	55
	Enter setup mode	58
	Exit setup mode	59
	Set control operator mode	60
	Clear control operator mode	61
	Set parameters to factory default	66
	Save statuses	87
	Keypad test	48
	Program terminator digit	131
	Terminator control	132
8.	<u>Transmitter settings</u>	
	Set hang time	72
	Set hang time TX 2	150
	Set TX 1 timeout time	73
	Set TX 2 timeout time	109
	Pulse TX2 off on enable	151
	Pulse TX2 off on disable	152
	Set TX2 off on Timer	153

9. Receiver settings

Set RX 1 COS voltage off level	79
Set RX 1 COS voltage on level	80
Set RX 1 CTCSS input voltage off level	83
Set RX 1 CTCSS input voltage on level	84
Set RX 2 COS voltage off level	81
Set RX 2 COS voltage on level	82
Set RX2 CTCSS off level	94
Set RX2 CTCSS on level	95
Set RX2 DTMF control	99
Program RX1 hang time TX1	157
Program RX2 hang time TX1	158

10. Remote base / Link functions

RX 2 and TX 2 disable	49
Disable TX 2	51
Enable TX 2	52
RX 2 enable	50
RX 2 enable w/memory select	53
RX 2 & TX 2 enable	117
RX 2 & TX 2 enable w/memory select	54
Set number of remote base memories	71
Set remote base home memory	90
Activate xpeat	105
Set port 2 to half duplex	106
Set port 2 to full duplex	107
Set port 2 to slave repeater	108
Report the current remote base memory number	129
Set memory report after memory select	130
Disable RX 2 TX 1 and TX 2	146
Enable RX 2 TX 1 and TX 2	147
Send response to TX 1 in xpeat enable	148
Send response to TX 1 in xpeat disable	149

11. Functions for TX 1 CTCSS encode (Linker IIa only)

Activate CTCSS encode hang timer	100
Deactivate CTCSS encode hang timer	101
Set CTCSS encode hang timer time	102
Activate CTCSS encode	103
Deactivate CTCSS encode	104
Enable RX 1 CTCSS encode activate	110
Disable RX 1 CTCSS encode activate	111
Enable RX 2 CTCSS encode activate	112
Disable RX 2 CTCSS encode activate	113
Force CTCSS encode on	125
Cancel CTCSS encode on	126

12. Antikerchunker functions

Enable antikerchunker filter RX 1	118
Disable antikerchunker filter RX 1	119
Enable antikerchunker filter RX 2	138
Disable antikerchunker filter RX 2	139
Set antikerchunker filter delay RX 1	120
Set antikerchunker filter interval time RX 1	121
Set antikerchunker filter delay RX 2	140
Set antikerchunker filter interval time RX 2	141

Definition of Terms used

1. Key up – To activate the Control or Repeaters receiver COS (The repeaters receiver needs to be allowed to do DTMF control)
2. Unkey – To deactivate The Control or Repeaters receiver COS
3. COMMAND ACCEPTED indication – The controller sends a CW letter “K” for “OK”
4. ENTER NEXT DATA code – The controller sends a CW letter “M” for “ready for MORE information”
5. TX 1 = Transmitter 1 (typically the repeaters transmitter)
6. TX 2 = Transmitter 2 (typically the remote base / link transmitter)
7. RX 1 = Receiver 1 (typically the repeaters receiver)
8. RX 2 = Receiver 2 (typically the remote base / link receiver)
9. FUNCTION = “command / function” as described in the previous text
10. A decimal point can be entered on some functions by using the ‘*’ key on your touch pad

FUNCTION: ENABLE TX 1

FUNCTION CODE: 32

PURPOSE: Enables the TX 1 output

HOW TO USE:

1. Key up
2. Enter the ENABLE TX 1 function code.
3. Unkey
4. The controller sends the COMMAND ACCEPTED indication
5. The TX 1 output is now enabled.

The ENABLE TX 1 command will enable TX 1. If TX 1 was disabled on power up TX 1 will again be disabled on power up (or warm reset) unless you use SAVE STATUSES (Function number 87). If you ENABLE TX 1 and then use the SAVE STATUSES function TX 1 will always be enabled when a power or warm reset occurs.

FUNCTION: DISABLE TX 1

FUNCTION CODE: 33

PURPOSE: Disables the TX 1 output

HOW TO USE:

1. Key up
2. Enter the DISABLE TX 1 function code
3. Unkey
4. The controller sends the COMMAND ACCEPTED indication
5. The TX 1 output is disabled.

The DISABLE TX 1 command will disable TX 1. If TX 1 was enabled on power up TX 1 will again be enabled on power up (or warm reset) unless you use SAVE STATUSES (Function number 87). If you DISABLE TX 1 and then use the SAVE STATUSES function TX 1 will always be disabled when a power or warm reset occurs.

FUNCTION: FORCE ID

FUNCTION CODE: 34

PURPOSE: To force the controller to send the CW ID

HOW TO USE:

1. Key up
2. Enter FORCE ID function code
3. Unkey
4. When the command is accepted the controller will send the preprogrammed CW ID.

When the controller sends a forced ID the ID interval timer is not reset.

FUNCTION: USE ONLY RX 1 COS INPUT

FUNCTION CODE: 35

PURPOSE: Changes the receiver 1 input to use the RX 1 COS input only

HOW TO USE:

1. Key up
2. Enter USE ONLY RX 1 COS INPUT function code
3. Unkey
4. The controller sends the COMMAND ACCEPTED indication
5. Receiver 1 will now only use the receiver 1 COS input

This function switches control for RX 1 only to the RX 1 COS input for receiver 1.

FUNCTION: USE ONLY RX 1 CTCSS INPUT

FUNCTION CODE: 36

PURPOSE: Changes the receiver 1 input to use the RX 1 CTCSS input only

HOW TO USE:

1. Key up
2. Enter USE ONLY RX 1 CTCSS INPUT function code
3. Unkey
4. The controller sends the COMMAND ACCEPTED indication
5. Now only the RX 1 CTCSS input will activate RX 1.

This function switches control for RX 1 to only the RX 1 CTCSS input

FUNCTION: TURN AUXILIARY TIMER OFF

FUNCTION CODE: 37

PURPOSE: Disables the timer for the auxiliary 1 output

HOW TO USE:

1. Key up
2. Enter the TURN AUXILIARY TIMER OFF function code
3. Unkey
4. The controller will send a COMMAND ACCEPTED indication
5. The auxiliary 1 output timer will no longer affect the auxiliary 1 output.

FUNCTION: TURN AUXILIARY TIMER ON

FUNCTION CODE: 38

PURPOSE: Enables the timer for the auxiliary 1 output

HOW TO USE:

1. Key up
2. Enter the TURN AUXILIARY TIMER ON function code
3. Unkey
4. The controller will send the COMMAND ACCEPTED indication
5. The auxiliary output timer is now enabled

The auxiliary 1 output timer will start when the auxiliary output is on. When the timer times out the auxiliary 1 output will be turned off.

FUNCTION: TURN AUXILIARY 1 OUTPUT OFF

FUNCTION CODE: 39

PURPOSE: Turns off the auxiliary 1 output

HOW TO USE:

1. Key up
2. Enter the TURN AUXILIARY 1 OUTPUT OFF function code
3. Unkey
4. The controller sends the COMMAND ACCEPTED indication
5. The auxiliary 1 output will now be turned off.

FUNCTION: TURN AUXILIARY 1 OUTPUT ON

FUNCTION CODE: 40

PURPOSE: Turns on the auxiliary 1 output ON

HOW TO USE:

1. Key up
2. Enter the TURN AUXILIARY OUTPUT ON function code
3. Unkey
4. The controller will send the COMMAND ACCEPTED indication
5. The auxiliary 1 output will be latched on.

If the auxiliary 1 output timer is enabled, the timer will turn the auxiliary 1 output off when the timer times out.

FUNCTION: TURN AUXILIARY 2 OUTPUT OFF

FUNCTION CODE: 41

PURPOSE: Turns off the auxiliary 2 output

HOW TO USE:

1. Key up
2. Enter the TURN AUXILIARY 2 OUTPUT OFF function code
3. Unkey
4. The controller sends the COMMAND ACCEPTED indication
5. The auxiliary 2 output is now turned off.

FUNCTION: TURN AUXILIARY 2 OUTPUT ON

FUNCTION CODE: 42

PURPOSE: Turns on the auxiliary 2 output ON

HOW TO USE:

1. Key up
2. Enter the TURN AUXILIARY OUTPUT ON code
3. Unkey
4. The controller will now send the COMMAND ACCEPTED function indication
5. The auxiliary 2 output is now latched on

Auxiliary 2 does not have a timeout timer.

Auxiliary 2 is also used as the PTT output for TX 2.

FUNCTION: TURN AUXILIARY 3 OUTPUT OFF

FUNCTION CODE: 43

PURPOSE: Turns off the auxiliary 3 output

HOW TO USE:

1. Key up
2. Enter the TURN AUXILIARY 3 OUTPUT OFF function code
3. Unkey
4. The controller sends the COMMAND ACCEPTED indication
5. The auxiliary 3 output is now turned off.

FUNCTION: TURN AUXILIARY 3 OUTPUT ON

FUNCTION CODE: 44

PURPOSE: Turns on the auxiliary 3 output ON

HOW TO USE:

1. Key up
2. Enter the TURN AUXILIARY OUTPUT ON function code
3. Unkey
4. The controller sends the COMMAND ACCEPTED indication
5. The auxiliary 3 output is now latched on.

Auxiliary 3 does not have a timeout timer.

Auxiliary 3 is also used for remote base memory selection.

FUNCTION: PULSE AUXILIARY 1 OUTPUT

FUNCTION CODE: 45

PURPOSE: Turns on the auxiliary 1 output

HOW TO USE:

1. Key up
2. Enter the PULSE AUXILIARY OUTPUT 1 function code
3. Unkey
4. The controller sends the COMMAND ACCEPTED indication
5. The auxiliary 1 output will be pulsed

FUNCTION: PULSE AUXILIARY 2 OUTPUT

FUNCTION CODE: 46

PURPOSE: Pulses the auxiliary 2 output

HOW TO USE:

1. Key up
2. Enter the PULSE AUXILIARY 2 OUTPUT function code
3. Unkey
4. The controller sends the COMMAND ACCEPTED indication
5. The auxiliary 2 output will be pulsed

FUNCTION: PULSE AUXILIARY 3 OUTPUT

FUNCTION CODE 47

PURPOSE: Pulses the auxiliary 3 output

HOW TO USE:

1. Key up
2. Enter the PULSE AUXILIARY 3 OUTPUT function code
3. Unkey
4. The controller sends the COMMAND ACCEPTED indication
5. The auxiliary 3 output will be pulsed.

FUNCTION: ACTIVATE KEYPAD TEST

FUNCTION CODE: 48

PURPOSE: Allows testing of users radio touch pad

HOW TO USE:

1. Key up
2. Enter the ACTIVATE KEYPAD TEST function code
3. Unkey
4. The controller sends the ENTER NEXT DATA indication
5. Key up
6. Push the digit to be tested
7. Unkey
8. The controller will report which DTMF digit it heard in CW

The controller will wait for another DTMF digit to be sent. If it you wish to cancel the function key up without sending a DTMF digit and unkey. The controller will cancel the keypad test with no acknowledge tone.

FUNCTION: RX 2 AND TX 2 DISABLE

FUNCTION CODE: 49

PURPOSE: Disables RX 2 and TX 2 and returns the remote base to the home memory

HOW TO USE:

1. Key up
2. Enter the RX 2 AND TX 2 DISABLE function code
3. Unkey
4. The controller sends the COMMAND ACCEPTED indication
5. RX 2 and TX 2 have been disabled and the memory (if it had been changed from memory 0) is incrementing back to memory 0 (the home memory).

FUNCTION: RX 2 ENABLE

FUNCTION CODE: 50

PURPOSE: Enables RX 2

HOW TO USE:

1. Key up
2. Enter the RX 2 ENABLE function code
3. Unkey
4. The controller sends the COMMAND ACCEPTED indication
5. RX 2 receiver will now be enabled.

The remote base memory will not be changed with this function

FUNCTION: TX 2 DISABLE

FUNCTION CODE: 51

PURPOSE: Disables TX 2

HOW TO USE:

1. Key up
2. Enter the TX 2 DISABLE function code
3. Unkey
4. The controller sends the COMMAND ACCEPTED indication
5. TX 2 is now disabled.

The remote base memory will not be changed with this function

FUNCTION: ENABLE TX 2

FUNCTION CODE: 52

PURPOSE: Enables TX 2

HOW TO USE:

1. Key up
2. Enter the ENABLE TX 2 function code
3. Unkey
4. The controller sends the COMMAND ACCEPTED indication
5. TX 2 will be enabled.

The remote base memory will not be changed with this function.

FUNCTION: RX 2 ENABLE WITH MEMORY SELECT

FUNCTION CODE: 53

PURPOSE: Enables RX 2 and will change the remote base memory

HOW TO USE:

1. Key up
2. Enter the RX 2 ENABLE WITH MEMORY SELECT function code
3. Unkey
4. The controller sends the ENTER NEXT DATA code
5. Key up
6. Enter the memory number you wish to have the remote base set to
7. Unkey
8. The controller sends the COMMAND ACCEPTED indication
9. The repeater transmitter (TX 1) will be forced on and a interment tone will be send while the memory are being selected.
10. The remote base memory will be selected
11. RX 2 is enabled
12. Once RX 2 is enabled the repeaters transmitter (TX 1) will no longer be forced on and the tone will stop.

FUNCTION: RX 2 AND TX 2 ENABLE WITH MEMORY SELECT

FUNCTION CODE: 54

PURPOSE: Enables RX 2 and TX 2 and will change the remote base memory

HOW TO USE:

1. Key up
2. Enter the RX 2 AND TX 2 ENABLE WITH MEMORY SELECT function code
3. Unkey
4. The controller sends the ENTER NEXT DATA indication
5. Key up
6. Enter the memory number you wish to have the remote base set to
7. Unkey
8. The controller sends the COMMAND ACCEPTED indication
9. The repeater transmitter (TX 1) will be forced on and a interment tone will be send while the memory are being selected.
10. The remote base memory will be selected
11. Then RX 2 and TX 2 will be enabled
12. Once RX 2 is enabled the repeaters transmitter (TX 1) will no longer be forced on and the tone will stop.

FUNCTION: WARM RESET

FUNCTION CODE: 55

PURPOSE: Resets all statuses to power up condition.

HOW TO USE:

1. Key up
2. Enter the WARM RESET function code
3. Unkey
4. There will be no direct acknowledging from the controller.

When you unkey after entering the WARM RESET code the transmitter will drop immediately as the controller does a reset and does not remember that the receiver was active.

FUNCTION: COURTESY TONE ENABLED

FUNCTION CODE: 56

PURPOSE: Enables the all of the courtesy tones.

HOW TO USE:

1. Key up
2. Enter the COURTESY TONE ENABLED function code
3. Unkey
4. The controller sends the COMMAND ACCEPTED indication
5. All the courtesy tones will enabled

To make this function permanent (Function stays active after power up or reset) the SAVE STATUSES function (function # 87) must be used.

FUNCTION: COURTESY TONE DISABLE

FUNCTION CODE: 57

PURPOSE: Disables the all of the courtesy tones.

HOW TO USE:

1. Key up
2. Enter the COURTESY TONE DISABLE function code
3. Unkey
4. The controller sends the COMMAND ACCEPTED indication
5. All the Courtesy tones will be disabled.

This function does not affect the acknowledge codes. The remote base, Setup mode and normal courtesy tones will be disabled. The COMMAND ACCEPTED and ENTER NEXT DATA indications will still operate.

FUNCTION: ENTER SETUP MODE

FUNCTION CODE: 58

PURPOSE: Puts the controller in the Setup mode

HOW TO USE:

1. Key up
2. Enter the ENTER SETUP MODE function code
3. Unkey
4. The controller sends the COMMAND ACCEPTED indication
5. The controller will be in the Setup mode

Entering the Setup mode with this command will occur regardless of the position of the setup jumper.

FUNCTION: EXIT SETUP MODE

FUNCTION CODE: 59

PURPOSE: Takes the controller out of the Setup mode

HOW TO USE:

1. Key up
2. Enter the EXIT SETUP MODE function code
3. Unkey
4. The controller sends the COMMAND ACCEPTED indication
5. The controller will not be in the setup mode.

Exiting the Setup mode with this command will occur regardless of the position of the setup jumper.

FUNCTION: SET CONTROL OPERATOR MODE

FUNCTION CODE: 60

PURPOSE: Puts the controller in the Control operator mode

HOW TO USE:

1. Key up
2. Enter the SET CONTROL OPERATOR MODE function code
3. Unkey
4. The controller sends the COMMAND ACCEPTED indication
5. The controller will be in the Control operator mode..

If the Control operator mode is enabled during the Setup mode it will have no effect until exiting the setup mode. Upon exiting the setup mode the controller will be in Control operator mode. The controller can be both in Setup mode and Control operator mode at the same time but the Setup mode has priority.

The control operator mode operates exactly like the user mode except it will allow access to DTMF command lines that are set to be accessible in the control operator mode.

FUNCTION: CLEAR CONTROL OPERATOR MODE
DTMF CODE: 61
PURPOSE: Takes the controller out of the control operator mode

HOW TO USE:

1. Key up
2. Enter the CLEAR CONTROL OPERATOR MODE function code
3. Unkey
4. The controller sends the COMMAND ACCEPTED indication
5. The controller will not be in the Control operator mode.

If the control operator mode is enabled during the Setup mode it will have no effect until exiting the Setup mode. Upon exiting the Setup mode the controller will be in Control operator mode. The controller can be both in Setup mode and control operator mode at the same time but the Setup mode has priority.

The control operator mode operates exactly like the user mode except it will allow access to DTMF command lines that are set to be accessible in the control operator mode.

When this command is used the control will be in the User mode.

FUNCTION: ENABLE IDER
FUNCTION CODE: 62
PURPOSE: Enables the IDer

HOW TO USE:

1. Key up
2. Enter the ENABLE IDER function code
3. Unkey
4. The controller sends the COMMAND ACCEPTED indication
5. The controller's IDer will now be enabled...

If the IDer was not enabled on power up the save statuses function will need to be run. This will store the new IDer status along with others. This needs to be done or the IDer status will return to the way it was the last time the controller was powered up when a warm reset or power on reset occur.

To make this function permanent (Function stays active after power up or reset) the SAVE STATUSES function (function # 87) must be used.

FUNCTION: DISABLE IDER

FUNCTION CODE: 63

PURPOSE: To keep IDer from IDing

HOW TO USE:

1. Key up
2. Enter the DISABLE IDER function code
3. Unkey
4. The controller will send the COMMAND ACCEPTED indication
5. The controller's IDer will now be disabled...

If the IDer was enabled on power up the save statuses function will need to be run. This will store the new IDer status (along with others). This needs to be done or the IDer status will return to the way it was the last time the controller was powered up.

To make this function permanent (Function stays active after power up or reset) the SAVE STATUSES function (function # 87) must be used.

FUNCTION: TURN ON TEST TONE

FUNCTION CODE: 64

PURPOSE: To provide an audio test signal from the controller

HOW TO USE:

1. Key up
2. Enter the TURN ON TEST TONE function code
3. Unkey
4. The controller sends the COMMAND ACCEPTED indication
5. The controller will send a continuous tone at the frequency that is currently set.

This function will not cause the transmitter to stay on. It only provides the tone from the tone output. The transmitter can be locked on by using the TX 1 force on function (#85).

FUNCTION: TURN OFF TEST TONE

FUNCTION CODE: 65

PURPOSE: To turn off the test tone signal from the controller

HOW TO USE:

1. Key up
2. Enter the TURN OFF TEST TONE function code
3. Unkey
4. The controller sends the COMMAND ACCEPTED indication
5. The controller will stop sending the test tone

FUNCTION: SET PARAMETERS TO THE FACTORY DEFAULT

FUNCTION CODE: 66

PURPOSE: Reset the listed parameters to the factory defaults

HOW TO USE:

1. Key up
2. Enter the SET PARAMETERS TO THE FACTORY DEFAULT function code
3. Unkey
4. The controller sends the COMMAND ACCEPTED indication
5. The Parameters are now set to the Factory Defaults

The factory defaults are as follows:

- | | |
|------------------------------------|------------------------------------|
| 1. Words per minute | 10 WPM |
| 2. CW frequency | 1000Hz |
| 3. TX 1 timeout time | 600 seconds |
| 4. TX 1 Hang time | 2 seconds |
| 5. RX 1 COR and CTCSS input levels | 2.5V positive action |
| 6. RX 2 COR and CTCSS input levels | 2.5V positive action |
| 7. Number of remote base memories | 10 |
| 8. Auxiliary 1 output timer time | 600 seconds |
| 9. IDer RX active hold off time | 150 seconds |
| 10. IDer interval time | 600 seconds |
| 11. Statuses are set to defaults | (See SAVE STATUSES Function (#87)) |

FUNCTION: SET IDER RX POLITE ID TIME

FUNCTION CODE: 67

PURPOSE: Sets the time to hold off the ID if the pending ID timer has timed out and the RX is active

HOW TO USE:

1. Key up
2. Enter the SET IDER RX ACTIVE HOLD OFF TIME function code
3. Unkey
4. The controller sends the ENTER NEXT DATA indication
5. Key up
6. Enter the time in seconds for the hold off time
7. Unkey
8. The controller sends the COMMAND ACCEPTED indication
9. The new time value is stored

The time range is from 30 seconds to 2500 seconds. If a value is entered outside these limits the controller will not save the entered value, it will give the ERROR indication (B in CW) and the function will be ended.

FUNCTION: SET IDER PENDING ID TIMER

FUNCTION CODE: 68

PURPOSE: Sets the time the IDer will wait before it tries to ID

HOW TO USE:

1. Key up
2. Enter the SET IDER PENDING ID function code
3. Unkey
4. The controller sends the ENTER NEXT DATA indication
5. Key up
6. Enter the time in seconds for the pending ID time
7. Unkey
8. The controller sends the COMMAND ACCEPTED
9. The value is changed.

The time range is from 30 seconds to 2500 seconds. If a value is entered outside these limits the controller will not save the entered value, it will give the ERROR indication (B in CW) and the function will be ended.

FUNCTION: SET AUXILIARY 1 OUTPUT TIMEOUT TIME

FUNCTION CODE: 69

PURPOSE: Changes the time for the auxiliary 1 timer

HOW TO USE:

1. Key up
2. Enter the SET AUXILIARY 1 OUTPUT TIMEOUT TIME function code
3. Unkey
4. The controller sends the ENTER NEXT DATA indication
5. Key up
6. Enter the time in seconds for the auxiliary 1 timeout timer
7. Unkey
8. The controller sends the COMMAND ACCEPTED indication
9. The timer value is changed.

The time range is from 10 seconds to 2520 seconds. If a value is entered outside these limits the controller will not save the entered value, it will give the ERROR indication (B in CW) and the function will be ended.

FUNCTION: SET WORD PER MINUTE RATE

FUNCTION CODE: 70

PURPOSE: Changes the word per minute rate for the CW output

HOW TO USE:

1. Key up
2. Enter the SET WORD PER MINUTE RATE function code
3. Unkey
4. The controller sends the ENTER NEXT DATA indication
5. Key up
6. Enter the time in seconds for the new wpm rate
7. Unkey
8. The controller sends the COMMAND ACCEPTED indication
9. The word per minute value is changed

The time range is from 5 wpm to 30 wpm. If a value is entered outside these limits the controller will not save the entered value, it will give the ERROR or BAD VALUE indication (B in CW) and the function will be ended.

FUNCTION: SET NUMBER OF REMOTE BASE MEMORIES

FUNCTION CODE: 71

PURPOSE: To tell the controller the number of memories the remote base is using

HOW TO USE:

1. Key up
2. Enter the SET NUMBER OF REMOTE BASE MEMORIES function code
3. Unkey
4. The controller sends the ENTER NEXT DATA indication
5. Key up
6. Enter the number of memories the remote base has that the controller will increment through
7. Unkey
8. The controller sends the COMMAND ACCEPTED indication
9. The number of remote base memories is set

The time range is from 1 memory to 254 memories. If a value is entered outside these limits the controller will not save the entered value, it will give the ERROR or BAD VALUE indication (B in CW) and the function will be ended.

When deciding the value for this function the actual number of memories that appears on the radio's display is what needs to be programmed in. The number to enter here is the actual number of memories that shows up on the remote base radios display when you go from the first memory to the last.

FUNCTION: SET HANG TIME

FUNCTION CODE: 72

PURPOSE Sets the time TX 1 is on after the receivers become inactive

HOW TO USE:

1. Key up
2. Enter the SET HANG TIME code
3. Unkey
4. The controller sends the ENTER NEXT DATA code
5. Key up
6. Enter the hang time in seconds
7. Unkey
8. The controller sends the COMMAND ACCEPTED indication
9. The new hang time value is stored

The range of the timer is from 0.1 seconds to 25 seconds. If a value is entered outside these limits the controller will not save the entered value, it will give the ERROR or BAD VALUE indication (B in CW) and the function will be ended. The timer is accurate to about 0.2 seconds and has a minimum of about a quarter of a second

To enter a decimal point use the ' * ' key. To enter the value 1.2 sec enter ' 1*2 ' on your DTMF keypad.

FUNCTION: SET TX 1 TIMEOUT TIME
FUNCTION CODE: 73
PURPOSE Sets the time TX 1 is allowed to be on

HOW TO USE:

1. Key up
2. Enter the SET TX 1 TIMEOUT TIME function code
3. Unkey
4. The controller sends the ENTER NEXT DATA code
5. Key up
6. Enter the time out time in seconds
7. Unkey
8. The controller sends the COMMAND ACCEPTED indication
9. The new timeout time value is stored

Sets the time maximum time TX 1 remains on after the receivers become inactive

The time range is from 10 seconds to 1200 seconds in 10-second increments. The accuracy is about 10 seconds. If a value is entered outside these limits the controller will not save the entered value, it will give the ERROR or BAD VALUE indication (B in CW) and the function will be ended.

If "0" is entered the TX 1 timer is disabled. TX 1 will not time out.

FUNCTION: CLEAR ALL DTMF COMMAND LINES
FUNCTION CODE: 74
PURPOSE: To clear all the DTMF memories

HOW TO USE:

1. Key up
2. Enter the CLEAR ALL DTMF COMMAND LINES function code
3. Unkey
4. The controller will send the COMMAND ACCEPTED indication
5. All of the DTMF codes are now cleared from the controller's EEPROM

If it is only necessary to clear one or a few DTMF lines / memories the CLEAR ONE DTMF COMMAND LINE function can be used.

FUNCTION: CLEAR ONE DTMF COMMAND LINE

FUNCTION CODE: 75

PURPOSE: To clear only one DTMF command line

HOW TO USE:

1. Key up
2. Enter the CLEAR ONE DTMF COMMAND LINE function code
3. Unkey
4. The controller sends the ENTER NEXT DATA indication
5. Key up
6. Enter the memory number of the DTMF line to clear
7. Unkey
8. The controller will send the COMMAND ACCEPTED indication
9. The DTMF codes in the selected line / memory are now cleared from the EEPROM

If it is desired to clear all of the DTMF command lines / memories from the EEPROM the CLEAR ALL DTMF COMMAND LINES function may be used.

FUNCTION: ENTER NEW ID

FUNCTION CODE: 76

PURPOSE: To set the information the IDer sends

HOW TO USE:

1. Key up
2. Enter the ENTER NEW ID function code
3. Unkey
4. The controller sends the ENTER NEXT DATA indication
5. Key up
6. Hold the key while entering in a series of 0's, 1's and 2's.
7. The 0's will enter a space, the 1's will enter a DIT and the 2's will enter a DAH.
8. When all the information is entered unkey.
9. The controller sends the COMMAND ACCEPTED indication
10. The new ID is stored

There is enough room to store as much as two call signs. If the controller did not like the information it received the controller will not save the entered data and it will give the ERROR or BAD VALUE indication (B in CW) and the function will be ended.

FUNCTION: SET NEW CW FREQUENCY

FUNCTION CODE: 77

PURPOSE: To set the frequency at which the controller sends any tone

HOW TO USE:

1. Key up
2. Enter the SET NEW CW FREQUENCY function code
3. Unkey
4. The controller sends the ENTER NEXT DATA indication
5. Key up
6. Enter the new frequency for the controller to send (from 400Hz to 1500Hz)
7. Unkey
8. The controller will send the COMMAND ACCEPTED indication
9. The DTMF codes in the selected line / memory are now cleared from the EEPROM

The frequency range is from 400Hz to 1500Hz. If a value is entered outside these limits the controller will not save the entered value, it will give the ERROR indication (B in CW) and the function will be ended.

FUNCTION: ENTER DTMF COMMAND LINE

FUNCTION CODE: 78

PURPOSE: To enter a DTMF code that when entered will do a function

HOW TO USE:

1. Key up
2. Enter the ENTER DTMF COMMAND LINE function code
3. Unkey, the controller sends the ENTER NEXT DATA indication
4. Key up
5. Enter the DTMF line memory number 0 to 24. (a total of 25 DTMF memories)
6. Unkey, the controller sends the next ENTER NEXT DATA indication
7. Key up
8. Enter the DTMF digits for the DTMF code, do not unkey while entering the 1 to 5 DTMF digits
9. Unkey, the controller sends the next ENTER NEXT DATA indication
10. Key up,
11. If this DTMF command line is to be used only at the Control operator's level (and only if) enter in "16"
12. Unkey, the controller sends the next ENTER NEXT DATA indication
13. Enter in the numerical value of the Function for this DTMF command line to do
14. Unkey, the controller sends the COMMAND ACCEPTED indication
15. The new DTMF command line is now stored in EEPROM

If the controller did not like the information it received the controller will not save the entered data and it will give the ERROR or BAD VALUE indication (B in CW) and the function will be ended. This can occur from step 4 to step 14

PLEASE NOTE: You must now Unkey after entering in the Control operator code (16) if you enter it.

FUNCTION: SET RX 1 COS VOLTAGE OFF LEVEL

FUNCTION CODE: 79

PURPOSE: Sets the RX 1 voltage which when reached the control will consider the receiver to be OFF

HOW TO USE:

1. Key up
2. Enter the SET RX 1 COS VOLTAGE OFF LEVEL function code
3. Unkey
4. The controller sends the ENTER NEXT DATA indication
5. Key up
6. Enter the COS voltage (1v to 9v) that when reached the controller should consider RX 1 to be OFF
7. Unkey
8. The controller sends the COMMAND ACCEPTED indication
9. The new RX 1 COS voltage off level is stored in EEPROM.
10. A cold or warm reset will be necessary to have the newly stored value used for RX 1 COS

The COS voltage entered can be from 1V to 9V and can be entered down to 0.01V. If the voltage value entered is not in the 1V to 9V range the controller will not save the entered data and it will give the ERROR or BAD VALUE indication (B in CW) and the function will be ended.

This sets the RX 1 COS off voltage. When setting the voltage care should be taken not to set it to the exact off voltage measured because the actual off voltage may not always be exactly the same. It is a good idea to set the off voltage at a level that is not quite at the final voltage when the input switches. This can help avoid misread signals when the system is in operation.

FUNCTION: SET RX 1 COS VOLTAGE ON LEVEL

FUNCTION CODE: 80

PURPOSE: Sets the RX 1 voltage which when reached the control will consider the receiver to be ON

HOW TO USE:

1. Key up
2. Enter the SET RX 1 COS VOLTAGE ON LEVEL function code
3. Unkey
4. The controller sends the ENTER NEXT DATA indication
5. Key up
6. Enter the COS voltage (1v to 9v) that when reached the controller should consider the RX 1 COS to be ON
7. Unkey
8. When the controller sends the COMMAND ACCEPTED indication these values have been entered
9. The new RX 1 COS voltage on level is stored in EEPROM.
10. A cold or warm reset will be necessary to have the newly stored value used for RX 1 COS

The COS voltage entered can be from 1V to 9V and can be entered down to 0.01V. If the COS voltage value entered is not in the 1V to 9V range the controller will not save the entered data and it will give the ERROR or BAD VALUE indication (B in CW) and the function will be ended.

This sets the RX 1 COS on voltage. When setting the voltage care should be taken not to set it to the exact on voltage measured because the actual on voltage may not always be exactly the same. It is a good idea to set the on voltage at a level that is not quite at the final voltage when the input switches. This can help avoid misread signals when the system is in operation.

FUNCTION: SET RX 2 COS VOLTAGE OFF LEVEL

FUNCTION CODE: 81

PURPOSE: Sets the RX 2 voltage which when reached the control will consider the receiver to be OFF

HOW TO USE:

1. Key up
2. Enter the SET RX 2 COS VOLTAGE OFF LEVEL function code
3. Unkey
4. The controller sends the ENTER NEXT DATA indication
5. Key up
6. Enter the COS voltage (1v to 9v) that when reached the controller should consider the RX 2 COS to be OFF
7. Unkey
8. When the controller sends the COMMAND ACCEPTED indication these values have been entered
9. The new RX 2 COS voltage off level is stored in EEPROM
10. A cold or warm reset will be necessary to have the newly stored value used for RX 2 COS

The COS voltage entered can be from 1V to 9V and can be entered down to 0.01V. The accuracy of this function is about 0.2V. If the voltage value entered is not in the 1V to 9V range the controller will not save the entered data and it will give the ERROR or BAD VALUE indication (B in CW) and the function will be ended.

This sets the RX 2 COS off voltage. When setting the voltage care should be taken not to set it to the exact off voltage measured because the actual voltage may not always be exactly the same. It is a good idea to set the voltage at a level that is not quite at the final voltage when the COS switches. This can help avoid misread signals when the system is in operation.

FUNCTION: SET RX 2 COS VOLTAGE ON LEVEL

FUNCTION CODE: 82

PURPOSE: Sets the RX 2 voltage which when reached the control will consider the receiver to be ON

HOW TO USE:

1. Key up
2. Enter the SET RX 2 COS VOLTAGE ON LEVEL function code
3. Unkey
4. The controller sends the ENTER NEXT DATA indication
5. Key up
6. Enter the COS voltage (1v to 9v) that when reached the controller should consider the RX 2 COS to be ON
7. Unkey
8. When the controller sends the COMMAND ACCEPTED indication these values have been entered
9. The new RX 2 COS voltage on level is stored in EEPROM
10. A cold or warm reset will be necessary to have the newly stored value used for RX 2 COS

The COS voltage entered can be from 1V to 9V and can be entered down to 0.01V. If the voltage data entered in is not in the 1V to 9V range the controller will not save the entered data and it will give the ERROR or BAD VALUE indication (B in CW) and the function will be ended.

This sets the RX 2 COS on voltage. When setting the voltage care should be taken not to set it to the exact voltage measured because the actual voltage may not always be exactly the same. It is a good idea to set the voltage at a level that is not quite at the final voltage when the COS switches. This can help avoid misread signals when the system is in operation.

FUNCTION: SET RX 1 CTCSS INPUT VOLTAGE OFF LEVEL

FUNCTION CODE: 83

PURPOSE: Sets the voltage which when reached the controller will consider the CTCSS to be OFF

HOW TO USE:

1. Key up
2. Enter the SET RX 1 CTCSS INPUT VOLTAGE OFF LEVEL function code
3. Unkey
4. The controller sends the ENTER NEXT DATA indication
5. Key up
6. Enter the voltage (1v to 9v) that when reached the controller should consider the CTCSS to be OFF
7. Unkey
8. When the controller sends the COMMAND ACCEPTED indication these values have been entered
9. The new RX 1 CTCSS voltage off level is stored in EEPROM
10. A cold or warm reset will be necessary to have the newly stored value used for CTCSS off

The CTCSS voltage entered can be from 1V to 9V and can be entered down to 0.01V. If the voltage value is not in the 1V to 9V range the controller will not save the entered data and it will give the ERROR or BAD VALUE indication (B in CW) and the function will be ended.

This sets the RX 1 CTCSS off voltage. When setting the voltage care should be taken not to set it to the exact voltage measured because the actual voltage may not always be exactly the same. It is a good idea to set the voltage at a level that is not quite at the final voltage when the CTCSS switches. This can help avoid misread signals when the system is in operation.

FUNCTION: SET RX 1 CTCSS INPUT VOLTAGE ON LEVEL

FUNCTION CODE: 84

PURPOSE: Sets the voltage which when reached the controller will consider the CTCSS to be ON

HOW TO USE:

1. Key up
2. Enter the SET RX 1 CTCSS INPUT VOLTAGE ON LEVEL function code
3. Unkey
4. The controller sends the ENTER NEXT DATA indication
5. Key up
6. Enter the COS voltage (1v to 9v) that when reached the controller should consider the RX 1 CTCSS to be ON
7. Unkey
8. When the controller sends the COMMAND ACCEPTED indication these values have been entered
9. The new RX 1 CTCSS voltage on level is stored in EEPROM
10. A cold or warm reset will be necessary to have the newly stored value used for RX 1 CTCSS on

The CTCSS voltage entered can be from 1V to 9V and can be entered down to 0.01V. The accuracy of this function is about 0.2V. If the voltage value is not in the 1V to 9V range the controller will not save the entered data and it will give the ERROR or BAD VALUE indication (B in CW) and the function will be ended.

This sets the RX 1 CTCSS on voltage. When setting the voltage care should be taken not to set it to the exact voltage measured because the actual voltage may not always be exactly the same. It is a good idea to set the voltage at a level that is not quite at the final voltage when the CTCSS switches. This can help avoid misread signals when the system is in operation.

FUNCTION: FORCE TX 1 ON

FUNCTION CODE: 85

PURPOSE: Forces TX 1 on

HOW TO USE:

1. Key up
2. Enter the FORCE TX 1 ON function code
3. Unkey
4. The controller sends the COMMAND ACCEPTED indication
5. TX 1 will be locked on.

The FORCE TX 1 ON will be cancelled when either the TX 1 FORCE CLEAR is used or when the TX 1 timeout timer times out.

FUNCTION: FORCE TX 1 ON CLEAR

DTMF CODE: 86

PURPOSE: Cancels the command FORCE TX 1 ON

HOW TO USE:

1. Key up
2. Enter the FORCE TX 1 ON CLEAR function code
3. Unkey
4. The controller sends the COMMAND ACCEPTED indication
5. If the FORCE TX 1 ON CLEAR command is active, the FORCE TX 1 ON command will now be canceled.

FUNCTION: SAVE STATUSES
FUNCTION CODE: 87
PURPOSE: Makes the current statuses permanent

HOW TO USE:

1. Key up
2. Enter the SAVE STATUSES function code
3. Unkey
4. The controller sends the COMMAND ACCEPTED indication
5. The controller's selected statuses will now be stored in EEPROM

The statuses need to be changed before using Save statuses. Save statuses just stores them the way it finds them from the controllers temporary RAM memory to the controllers permanent EEPROM memory.

This command will put the value of the statuses listed below in EEPROM memory so they are as currently in RAM when the controller is powered up again. If the Save statuses function is not used and any of these values are changed the values will go back to what they were before power up. The factory defaults are also shown below;

- | | |
|-------------------------------|-----------------------|
| 1. TX ENABLED | Default = TRUE |
| 2. ID ENABLED | Default = TRUE |
| 3. BEEP ENABLED | Default = TRUE |
| 4. AUXILIARY 1 TIMER ENABLED | Default = TRUE |
| 5. DTMF MUTING ENABLED | Default = TRUE |
| 6. ENABLE TX FAN | Default = FALSE |
| 7. RX 1 COR IN AND / OR MODE | Default = FALSE |
| 8. RX 2 COR IN AND / OR MODE | Default = FALSE |
| 9. DTMF CONTROL ON RX 2 INPUT | Default = FALSE |
| 10. Port 2 Mode status | Default = HALF DUPLEX |
| 11. FORCE CTCSS ON | Default = FALSE |

FUNCTION: ENABLE TIMED TX FAN ON AUXILIARY 1 OUTPUT

FUNCTION CODE: 88

PURPOSE: To enable control for a transmitter fan for TX 1 on auxiliary 1 output

HOW TO USE:

1. Key up
2. Enter the ENABLE TIMED TX FAN ON AUXILIARY 1 OUTPUT function code
3. Unkey
4. The controller sends the COMMAND ACCEPTED indication
5. The TX 1 fan output is now enabled on the auxiliary 1 output

This function will turn on its output when TX 1 comes on and remain on for a preset time after TX 1 goes off. The output used for this function is the auxiliary 1 output. The auxiliary 1 output timer is used for the fan timer. It starts when TX 1 goes off. To set the time for this function use the SET AUXILIARY 1 OUTPUT TIMEOUT TIME function (function code 69).

The ENABLE TIMED TX FAN ON AUXILIARY 1 OUTPUT command will enable the TX fan. If the TX fan was disabled on power up the TX FAN will again be disabled on power up (or warm reset) unless you use the SAVE STATUSES (Function number 87). If you ENABLE TIMED TX FAN ON AUXILIARY 1 OUTPUT and then use the SAVE STATUSES function the TX fan will always be enabled when a power or warm reset occurs.

FUNCTION: DISABLE TIMED TX FAN ON AUXILIARY 1 OUTPUT

FUNCTION CODE: 89

PURPOSE: To disable control for a transmitter fan for TX 1 on Auxiliary 1 output

HOW TO USE:

1. Key up
2. Enter the DISABLE TIMED TX FAN ON AUXILIARY 1 OUTPUT function code
3. Unkey
4. The controller sends the COMMAND ACCEPTED indication
5. The fan output is now disabled

The DISABLE TIMED TX FAN ON AUXILIARY 1 OUTPUT command will disable the TX fan. If the TX fan was enabled on power up the TX FAN will again be enabled on power up (or warm reset) unless you use the SAVE STATUSES (Function number 87). If you DISABLE TIMED TX FAN ON AUXILIARY 1 OUTPUT and then use the SAVE STATUSES function the TX fan will always be disabled when a power or warm reset occurs.

FUNCTION: USE CURRENT MEMORY AS REMOTE BASE HOME MEMORY

FUNCTION CODE: 90

PURPOSE: To tell the controller the remote base is now on memory zero (home memory)

HOW TO USE:

1. Key up
2. Enter the USE CURRENT MEMORY AS REMOTE BASE HOME MEMORY function code
3. Unkey
4. The controller sends the COMMAND ACCEPTED indication
5. The current memory in the remote base is now Memory 0 or Home memory to the controller

The Linker IIa controller uses EEPROM to remember what memory the remote base is set to. This function provides a method to tell the Linker IIa what memory in the remote base radio to use as memory 0 or the Home memory. When you use this function the controller will consider the current remote base memory to be memory 0 or the home memory.

FUNCTION: TURN DTMF MUTING ON

FUNCTION CODE: 91

PURPOSE: Tell the controller to mute audio when DTMF tones are heard

HOW TO USE:

1. Key up
2. Enter the TURN DTMF MUTING ON function code
3. Unkey
4. The controller sends the COMMAND ACCEPTED indication
5. The DTMF tones will now be muted

The TURN DTMF MUTING ON command will enable DTMF muting. If DTMF muting was disabled on power up the DTMF muting will again be disabled on power up (or warm reset) unless you use the SAVE STATUSES (Function number 87). If you TURN DTMF MUTING ON and then use the SAVE STATUSES function the DTMF muting will always be enabled after a power up or warm reset occurs.

If DTMF control is not enabled on RX 2 the control will not mute if tones come in from RX 2.

FUNCTION: TURN DTMF MUTING OFF

FUNCTION CODE: 92

PURPOSE: Set the controller not to mute RX1 or RX2 audio when DTMF tones are heard

HOW TO USE:

1. Key up
2. Enter the TURN DTMF MUTING OFF function code
3. Unkey
4. The controller sends the COMMAND ACCEPTED indication
5. The DTMF tones will now not be muted

The TURN DTMF MUTING OFF command will disable DTMF muting. If DTMF muting was enabled on power up the DTMF muting will again be enabled on power up (or warm reset) unless you use the SAVE STATUSES (Function number 87). If you TURN DTMF MUTING OFF and then use the SAVE STATUSES function the DTMF muting will always be disabled after a power up or warm reset occurs.

FUNCTION: AND RX 1 COS AND CTCSS INPUTS

FUNCTION CODE: 93

PURPOSE: Requires an AND condition for a valid RX1 ACTIVE condition

HOW TO USE:

1. Key up
2. Enter the SET RX1 COS TO AND function code
3. Unkey
4. The controller sends the COMMAND ACCEPTED indication
5. The controller is now in AND mode on receiver 1 (RX1, port 1)

This function when enabled will set the receiver #1 input (RX1) to require both the RX1 main input and the RX1 CTCSS input to be active (AND condition) before an active receiver condition is recognized by the controller.

To make this function permanent (Function stays active after power up or reset) the SAVE STATUSES function (function # 87) must be used.

FUNCTION: SET RX 2 CTCSS OFF LEVEL

FUNCTION CODE: 94

PURPOSE: Sets the voltage which when reached the control will consider this input to be off

HOW TO USE:

1. Key up
2. Enter the SET RX 2 CTCSS OFF LEVEL function code
3. Unkey
4. The controller sends the ENTER NEXT DATA indication
5. Key up
6. Enter the CTCSS voltage (1v to 9v) that when reached the controller should consider RX 2 CTCSS to be OFF
7. Unkey
8. When the controller sends the COMMAND ACCEPTED indication these values have been entered
9. The new RX 2 CTCSS input voltage off level is stored in EEPROM
10. A reset or power down / power up action will be necessary to have the new value for the RX 2 CTCSS input

The voltage entered can be from 1V to 9V and can be entered down to 0.01V. If the voltage value is not in the 1V to 9V range the controller will not save the entered voltage and it will give the ERROR or BAD VALUE indication (B in CW) .

This sets the RX 2 CTCSS off voltage. When setting the voltage care should be taken not to set it to the exact voltage measured because the actual voltage may not always be exactly the same. It is a good idea to set the voltage at a level that is not quite at the final voltage the CTCSS reaches. This can help avoid problems if the voltage changes slightly.

FUNCTION: SET RX 2 CTCSS ON LEVEL

FUNCTION CODE: 95

PURPOSE: Sets the voltage which when reached the control will consider this input to be on

HOW TO USE:

1. Key up
2. Enter the SET RX 2 CTCSS ON LEVEL function code
3. Unkey
4. The controller sends the ENTER NEXT DATA indication
5. Key up
6. Enter the CTCSS voltage (1v to 9v) that when reached the controller should consider RX 2 CTCSS to be ON
7. Unkey
8. When the controller sends the COMMAND ACCEPTED indication these values have been entered
9. The new RX 2 CTCSS input voltage on level is stored in EEPROM

A cold or warm reset will be necessary to have the newly stored value used for RX 2 CTCSS

The voltage entered can be from 1V to 9V and can be entered down to 0.01V. If the entered voltage is not in the 1V to 9V range or if it is the same as the 'OFF' voltage the controller will not save the entered voltage and it will give the ERROR or BAD VALUE indication (B in CW) .

This sets the RX 2 CTCSS on voltage. When setting the voltage care should be taken not to set it to the exact voltage measured because the actual voltage may not always be exactly the same. It is a good idea to set the voltage at a level that is not quite at the final voltage the CTCSS reaches. This can help avoid problems if the voltage changes slightly.

FUNCTION: USE ONLY RX 2 COS INPUT

FUNCTION CODE: 96

PURPOSE: Changes the COS input which RX 2 uses to the RX 2 COS input only

HOW TO USE:

1. Key up
2. Enter USE ONLY RX 2 COS INPUT function code
3. Unkey
4. The controller sends the COMMAND ACCEPTED indication
5. The RX 2 COS will now activate RX 2.

This function switches control for RX 2 to the RX 2 COS input.

To make this function permanent (Function stays active after power up or reset) the SAVE STATUSES function (function # 87) must be used.

FUNCTION: USE ONLY RX 2 CTCSS INPUT

FUNCTION CODE: 97

PURPOSE: Changes the input RX 2 uses to the RX 2 CTCSS input

HOW TO USE:

1. Key up
2. Enter the USE ONLY RX 2 CTCSS INPUT function code
3. Unkey
4. The controller sends the COMMAND ACCEPTED indication
5. The controller will now look for a valid signal from the RX 2 CTCSS input for a valid receive signal

This function switches control for RX 2 the RX 2 CTCSS input.

This function status will *not* be saved with the SAVE STATUSES command.

FUNCTION: AND RX 2 COS AND CTCSS INPUTS

FUNCTION CODE: 98

PURPOSE: Requires an AND condition for a valid RX 2 receiver active signal

HOW TO USE:

1. Key up
2. Enter the AND RX 2 COS AND CTCSS INPUTS function code
3. Unkey
4. The controller sends the COMMAND ACCEPTED indication
5. The controller is now in AND mode on receiver 2 (RX2, port 2)

This function, when enabled will set the receiver #2 input (RX 2) to require both the RX 2 COS input and the RX 2 CTCSS input to be active (AND condition) before an active RX 2 receive signal is recognized by the software.

To make this function permanent (Function stays active after power up or reset) the SAVE STATUSES function (Function #87) must be used.

FUNCTION: SET RX2 DTMF CONTROL

FUNCTION CODE: 99

PURPOSE: Tell the controller to allow or not allow DTMF control from the RX 2 input

HOW TO USE:

1. Key up
2. Enter the SET RX2 DTMF CONTROL function code
3. Unkey
4. The controller sends ENTER NEXT DATA indication
5. Enter a '1' to allow RX 2 DTMF control or a '0' to Not allow RX 2 DTMF control
6. Unkey
7. The controller sends the COMMAND ACCEPTED indication
8. If a '1' was entered DTMF control can now be done from the RX 2 receiver input

This function will allow you to enable or disable DTMF control from RX 2. Entering a '1' enables the DTMF control and entering a '0' disallows DTMF control from the RX 2 input or port.

The default status (factory default) is DTMF control is not allowed from RX 2.

To keep the current setting of this function you must use the SAVE STATUSES command (command #87). This will insure the current status of this setting will be maintained upon power up and reset.

FUNCTION: ACTIVATE CTCSS ENCODE HANG TIMER

FUNCTION CODE: 100

PURPOSE: Tells the controller to keep the CTCSS encode on after the receiver goes off while the CTCSS hang timer is running

HOW TO USE:

1. Keyup
2. Enter the ACTIVATE CTCSS ENCODE HANG TIMER function code
3. Unkey
4. The controller sends the COMMAND ACCEPTED indication.
5. The CTCSS encode will now stay on after the receiver goes off while the CTCSS hang timer is running

The CTCSS encode has to be enabled (command #103) before the encode tone will be sent.

FUNCTION: DEACTIVATE CTCSS ENCODE HANG TIMER

FUNCTION CODE: 101

PURPOSE: Tells the controller to disable the CTCSS encode hang time timer function

HOW TO USE:

1. Keyup
2. Enter the DEACTIVATE CTCSS ENCODE HANG TIMER function code
3. Unkey
4. The controller send the COMMAND ACCEPTED indication.
5. The CTCSS encode will now not stay on after the receiver goes off.

FUNCTION: SET CTCSS ENCODE HANG TIME

FUNCTION CODE: 102

PURPOSE: Sets the amount of time the CTCSS stays on after the receiver goes off if enabled

HOW TO USE:

1. Keyup
2. Enter the ACTIVATE CTCSS ENCODE HANG TIMER function code
3. Unkey
4. The controller sends the ENTER NEXT DATA indication
5. Keyup
6. Enter the number of seconds (from 0s to 25s) in seconds.
7. Unkey
8. The controller send the COMMAND ACCEPTED indication.
9. The newly entered CTCSS encode hang time is now used

FUNCTION: ACTIVATE CTCSS ENCODE

FUNCTION CODE: 103

PURPOSE: Turns on the CTCSS encode function

HOW TO USE:

1. Keyup
2. Enter the ACTIVATE CTCSS ENCODE function code
3. Unkey
4. The controller sends the COMMAND ACCEPTED indication.
5. The CTCSS encode will now be active when the repeater or link receiver is active.

FUNCTION: DEACTIVATE CTCSS ENCODE

FUNCTION CODE: 104

PURPOSE: Turns off the CTCSS encode function

HOW TO USE

1. Keyup
2. Enter the DEACTIVATE CTCSS ENCODE function code
3. Unkey
4. The controller sends the COMMAND ACCEPTED indication.
5. The CTCSS encode will now be disabled.

This function will disable any CTCSS tone on the TX 1 output.

FUNCTION: ACTIVATE XPEAT

FUNCTION CODE: 105

PURPOSE: Tells the controller to operate in the XPEAT mode

HOW TO USE:

1. Keyup
2. Enter the ACTIVATE XPEAT function code
3. Unkey
4. The controller sends the COMMAND ACCEPTED indication.
5. The controller will now operate in the XPEAT mode

The XPEAT mode will transmit on TX 2 when RX 1 is activated and on TX 1 when RX 2 is activated. Only one path will operate at a time. RX 1 to TX 1 will have priority.

This status (controller in XPEAT mode will be the power up mode if the SAVE STATUSES function (#87) is used. In the XPEAT mode the IDER will function on TX 1. Please note, the IDER will work in XPEAT in versions starting with version 1.22 of the Linker IIa software.

To make this function permanent (Function stays active after power up or reset) the SAVE STATUSES function (function # 87) must be used.

FUNCTION: SET PORT 2 TO HALF DUPLEX

FUNCTION CODE: 106

PURPOSE: Tells the controller to allow either RX 2 or TX 2 to operate – not both

HOW TO USE

1. Keyup
2. Enter the SET PORT 2 TO HALF DUPLEX function code
3. Unkey
4. The controller sends the COMMAND ACCEPTED indication.
5. RX 2 and TX 2 will now not operate at the same time.

When Port 2 is in HALF DUPLEX it will active TX 1 and TX 2 when RX 1 becomes active but the controller will only activate TX 1 if RX 2 becomes active.

To make this function permanent (Function stays active after power up or reset) the SAVE STATUSES function (function # 87) must be used.

This is the Default mode for Port 2.

FUNCTION: SET PORT 2 TO FULL DUPLEX

FUNCTION CODE: 107

PURPOSE: Sets Port 2 to full duplex

HOW TO USE:

1. Keyup
2. Enter the SET PORT 2 TO FULL DUPLEX function code
3. Unkey
4. The controller sends the COMMAND ACCEPTED indication.
5. Port 2 will now operate in full duplex mode.

When Port 2 is in full duplex TX 1 and TX 2 will always be activated when either RX 1 or RX 2 is active.

To make this function permanent (Function stays active after power up or reset) the SAVE STATUSES function (function # 87) must be used.

FUNCTION: SET PORT 2 TO SLAVE REPEATER

FUNCTION CODE: 108

PURPOSE: Puts the controller into Slave Repeater Mode

HOW TO USE:

1. Keyup
2. Enter the SET PORT 2 TO SLAVE REPEATER function code
3. Unkey
4. The controller sends the COMMAND ACCEPTED indication.
5. The SET PORT 2 TO SLAVE REPEATER encode will now be enabled.

This function will put the controller into slave repeater mode. The slave repeater mode allows the operation of two repeaters at one time. The repeaters will have the same audio and will ID at the same time.

To make this function permanent (Function stays active after power up or reset) the SAVE STATUSES function (function # 87) must be used.

FUNCTION: SET TX 2 TIMEOUT TIME

FUNCTION CODE: 109

PURPOSE Sets the time TX 2 is allowed to be on

HOW TO USE:

1. Key up
2. Enter the SET TX 2 TIMEOUT TIME function code
3. Unkey
4. The controller sends the ENTER NEXT DATA code
5. Key up
6. Enter the time out time in seconds
7. Unkey
8. The controller sends the COMMAND ACCEPTED indication
9. The new timeout time value is stored

Sets the time maximum time TX 2 remains on after the receivers become inactive

The time range is from 0 seconds to 1200 seconds in 10-second increments. The accuracy is about 10 seconds. If a value is entered outside these limits the controller will not save the entered value, it will give the ERROR or BAD VALUE indication (B in CW) and the function will be ended.

If "0" is entered the TX 2 timer is disabled. TX 2 will not time out.

FUNCTION: ENABLE RX 1 CTCSS ENCODE ACTIVATE

FUNCTION CODE: 110

PURPOSE To allow activation of the CTCSS encode on TX 1 when RX 1 is active

HOW TO USE:

1. Keyup
2. Enter the ENABLE RX 1 CTCSS ENCODE ACTIVATE function code
3. Unkey
4. The controller sends the COMMAND ACCEPTED indication.
5. RX 1 will now activate the CTCSS encode on TX 1 when RX 1 is active.

To make this function permanent (function stays active after power up or reset) the SAVE STATUSES function (function # 87) must be used.

FUNCTION: DISABLE RX 1 CTCSS ENCODE ACTIVATE

FUNCTION CODE: 111

PURPOSE To not allow RX 1 to activate the encode on TX 1 when RX 1 is active

HOW TO USE:

1. Keyup
2. Enter the DISABLE RX 1 CTCSS ENCODE ACTIVATE function code
3. Unkey
4. The controller sends the COMMAND ACCEPTED indication.
5. RX 1 will now not activate the CTCSS encode on TX 1 when RX 1 is active.

To make this function permanent (function stays active after power up or reset) the SAVE STATUSES function (function # 87) must be used.

FUNCTION: ENABLE RX 2 CTCSS ENCODE ACTIVATE

FUNCTION CODE: 112

PURPOSE To allow activation of the CTCSS encode on TX 1 when RX 2 is active

HOW TO USE:

1. Keyup
2. Enter the ENABLE RX 2 CTCSS ENCODE ACTIVATE function code
3. Unkey
4. The controller sends the COMMAND ACCEPTED indication.
5. RX 2 will now activate the CTCSS encode on TX 1 when RX 2 is active.

To make this function permanent (function stays active after power up or reset) the SAVE STATUSES function (function # 87) must be used. This function is a factory default.

FUNCTION: DISABLE RX 2 CTCSS ENCODE ACTIVATE

FUNCTION CODE: 113

PURPOSE To not allow RX 2 to activate the encode on TX 1 when RX 1 is active

HOW TO USE:

1. Keyup
2. Enter the DISABLE RX 2 CTCSS ENCODE ACTIVATE function code
3. Unkey
4. The controller sends the COMMAND ACCEPTED indication.
5. RX 2 will now not activate the CTCSS encode on TX 1 when RX 2 is active.

To make this function permanent (function stays active after power up or reset) the SAVE STATUSES function (function # 87) must be used.

FUNCTION: ACTIVATE BEACON MODE

FUNCTION CODE: 114

PURPOSE Sets the IDer to operate in 'Beacon Mode'

HOW TO USE:

1. Key up
2. Enter the ACTIVATE BEACON MODE function code
3. Unkey
4. The controller sends the COMMAND ACCEPTED indication
5. The controller is now in Beacon Mode mode

To make this function permanent (function stays active after power up or reset) the SAVE STATUSES function (function # 87) must be used.

In Beacon mode the IDer will ID whether or not the transmitter has been activated. The time in-between IDs will be what the pending ID timer (See Function #68) is set to. If a receiver input is active when the pending ID timer times out the IDer will start the polite ID timer (See Function #67). The IDer will not ID until the polite ID timer times out or the receiver input is no longer active.

FUNCTION: DEACTIVATE BEACON MODE

FUNCTION CODE: 115

PURPOSE Sets the IDer back to normal mode – disables the Beacon function

HOW TO USE:

1. Key up
2. Enter the DEACTIVATE BEACON MODE function code
3. Unkey
4. The controller sends the COMMAND ACCEPTED indication
5. The controller will now not be in Beacon mode

To make this function permanent (function stays active after power up or reset) the SAVE STATUSES function (function # 87) must be used. This is a factory default (see set factory defaults, function #66)

FUNCTION: SET TIME FOR PULSE ON AUXILIARY 3

FUNCTION CODE: 116

PURPOSE To set the time the Auxiliary 3 pulse will be on when auxiliary 3 is pulsing

HOW TO USE:

1. Key up
2. Enter the SET TIME FOR PULSE ON AUXILIARY 3 Function code
3. Unkey
4. The controller sends the ENTER NEXT DATA indication
5. Key up
6. Enter the time in seconds for the Auxiliary 3 pulse time
7. Unkey
8. The controller sends the COMMAND ACCEPTED
9. The value is changed.

The time range is from .004 second to 1.000 second. If a value is entered outside these limits the controller will not save the entered value, it will give the ERROR indication (B in CW) and the function will be ended. Use the '*' key for the decimal point. You can only enter 4 digits (the decimal point counts as a digit).

FUNCTION: RX 2 AND TX 2 ENABLE

FUNCTION CODE: 117

PURPOSE Enables RX 2 and TX 2

HOW TO USE:

1. Key up
2. Enter the RX 2 AND TX 2 ENABLE function code
3. Unkey
4. The controller sends the COMMAND ACCEPTED indication
5. Now RX 2 and TX 2 are enabled

To make this function permanent (Function stays active after power up or reset) the SAVE STATUSES function (function # 87) must be used.

FUNCTION: ENABLE ANTIKERCHUNKER FILTER

FUNCTION CODE: 118

PURPOSE Enables the Antikerchunker filter

HOW TO USE:

1. Key up
2. Enter the ENABLE ANTIKERCHUNKER FILTER function code
3. Unkey
4. The controller sends the COMMAND ACCEPTED indication
5. Now the Antikerchunker filter is enabled

To make this function permanent (Function stays active after power up or reset) the SAVE STATUSES function (function # 87) must be used.

FUNCTION: DISABLE ANTIKERCHUNKER FILTER
FUNCTION CODE: 119

PURPOSE Disables the Antikerchunker filter

HOW TO USE:

1. Key up
2. Enter the DISABLE ANTIKERCHUNKER FILTER function code
3. Unkey
4. The controller sends the COMMAND ACCEPTED indication
5. Now the Antikerchunker filter is enabled

To make this function permanent (Function stays active after power up or reset) the SAVE STATUSES function (function # 87) must be used.

FUNCTION: SET ANTIKERCHUNKER FILTER DELAY

FUNCTION CODE: 120

PURPOSE Allows changes to the Antikerchunker delay time

HOW TO USE:

1. Key up
2. Enter the SET ANTIKERCHUNKER FILTER DELAY function code
3. Unkey
4. The controller sends the ENTER NEXT DATA indication
5. Key up
6. Enter the time in seconds
7. Unkey
8. The controller sends the COMMAND ACCEPTED indication
9. Now the Antikerchunker filter is set to the entered value

The range of the delay timer is 0.1s to 25s. This timer sets the amount of time the receiver needs to be active before the antikerchunker filter stops filtering. Use the '*' key for the decimal point. You can only enter 4 digits (the decimal point counts as a digit).

FUNCTION: SET ANTIKERCHUNKER FILTER INTERVAL TIME

FUNCTION CODE: 121

PURPOSE: Allows changes to the interval timer - the time before the Linker IIa restarts the Antikerchunker filter

HOW TO USE:

1. Key up
2. Enter the SET ANTIKERCHUNKER FILTER INTERVAL TIME function code
3. Unkey
4. The controller sends the ENTER NEXT DATA indication
5. Key up
6. Enter the time in seconds
7. Unkey
8. The controller sends the COMMAND ACCEPTED indication
9. Now the Antikerchunker filter interval time is set to the entered value

The range of the interval timer is 10s to 2500 seconds. This timer starts after the antikerchunker times out. When this timer times out the antikerchunker filter is again started.

FUNCTION: SET PREBEEP TIME

FUNCTION CODE: 122

PURPOSE Sets the time from when RX1 is determined to be off and the courtesy tone starts

HOW TO USE:

1. Key up
2. Enter the SET PREBEEP TIME function code
3. Unkey
4. The controller sends the ENTER NEXT DATA indication
5. Key up
6. Enter the time in seconds
7. Unkey
8. The controller sends the COMMAND ACCEPTED indication
9. Now the Prebeep time is set to the entered value

The minimum Prebeep time that can be set is 0.1 seconds, the maximum Prebeep time that can be set is 25 seconds. If a value is entered outside this range the controller will send a Morse code "B" (for Bad data) and the bad data will not be saved. Use the '*' key for the decimal point. You can only enter 4 digits (the decimal point counts as a digit).

FUNCTION: OR RX 1 COS AND CTCSS INPUTS

FUNCTION CODE: 123

PURPOSE: Requires an OR condition for a valid RX1 ACTIVE condition

HOW TO USE:

1. Key up
2. Enter the SET RX1 COS TO OR function code
3. Unkey
4. The controller sends the COMMAND ACCEPTED indication
5. The controller is now in OR mode on receiver 1 (RX1, port 1)

This function when enabled will set the receiver #1 input (RX1) to require both the RX1 main input and the RX1 CTCSS input to be active (OR condition) before an active receiver condition is recognized by the controller.

To make this function permanent (Function stays active after power up or reset) the SAVE STATUSES function (function # 87) must be used.

FUNCTION: OR RX 2 COS AND CTCSS INPUTS

FUNCTION CODE: 124

PURPOSE: Requires an OR condition for a valid RX1 ACTIVE condition

HOW TO USE:

1. Key up
2. Enter the SET RX2 COS TO OR function code
3. Unkey
4. The controller sends the COMMAND ACCEPTED indication
5. The controller is now in OR mode on receiver 2 (RX2, port 2)

This function when enabled will set the receiver #1 input (RX1) to require both the RX2 main input and the RX2 CTCSS input to be active (OR condition) before an active receiver condition is recognized by the controller.

To make this function permanent (Function stays active after power up or reset) the SAVE STATUSES function (function # 87) must be used.

FUNCTION: FORCE CTCSS ENCODE ON

FUNCTION CODE: 125

PURPOSE: Turns on the CTCSS encode and keeps it on

HOW TO USE:

1. Key up
2. Enter the FORCE CTCSS ENCODE ON function code
3. Unkey
4. The controller sends the COMMAND ACCEPTED indication
5. The controller now forces on the CTCSS encode

When the CTCSS encode is forced on it will stay on independent of any other condition. The CTCSS encode will remain on regardless of the status of the transmitters, receivers or the CTCSS encode hang time.

This function is available starting with V1.16 of the Linker IIa software.

FUNCTION: CANCEL FORCE CTCSS ENCODE ON

FUNCTION CODE: 126

PURPOSE: Cancels the force CTCSS encode force on

HOW TO USE:

1. Key up
2. Enter the CANCEL FORCE CTCSS ENCODE ON function code
3. Unkey
4. The controller sends the COMMAND ACCEPTED indication
5. The controller will no longer force the CTCSS encode on

If the FORCE CTCSS ENCODE ON is active and this function is used the controller will stop forcing the CTCSS encode to be on. The CTCSS encode will operate according to the statuses of the CTCSS encode and the CTCSS encode hang time.

This function is available starting with V1.16 of the Linker IIa software

FUNCTION: CHANGE A PROGRAMMABLE TONE

FUNCTION CODE: 127

PURPOSE: Allows you to change one of the programmable tones

HOW TO USE:

1. Key up
2. Enter the CHANGE A PROGRAMMABLE TONE function code
3. Unkey
4. The controller sends the ENTER NEXT DATA indication
5. Key up
6. Enter the programmable tone number you wish to change
7. Unkey
8. The controller sends the ENTER NEXT DATA indication
9. Key up
10. Enter the tone number you wish to use for the selected programmable tone.
11. Unkey
12. The controller sends the COMMAND ACCEPTED indication

The available programmable tones and the available tones are at the end of the manual, you can find the page number in the table of contents.

This function is available starting with V1.17 of the Linker II and Linker IIa software.

FUNCTION: PLAY A TONE

FUNCTION CODE: 128

PURPOSE: This function will play one of the available tones

HOW TO USE:

1. Key up
2. Enter the PLAY A TONE function code
3. Unkey
4. The controller sends the ENTER NEXT DATA indication
5. Key up
6. Enter the tone to play
7. Unkey
8. The controller sends the selected tone

The available tones are at the end of the manual, you can find the page number in the table of contents.

This function is available starting with V1.17 of the Linker II and Linker IIa software

FUNCTION: REPORT THE CURRENT REMOTE BASE MEMORY NUMBER

FUNCTION CODE: 129

PURPOSE: Tells you what memory the remote base is set to

HOW TO USE:

1. Key up
2. Enter the REPORT THE CURRENT REMOTE BASE MEMORY NUMBER function code
3. Unkey
4. The controller now reports the current remote base memory number in morse code

This function is available starting with V1.17 of the Linker II and Linker IIa software.

FUNCTION: SET MEMORY REPORT AFTER MEMORY SELECT

FUNCTION CODE: 130

PURPOSE: This function allows the user to enable or disable the reporting of the memory after the remote base memory has been selected by the controller.

HOW TO USE:

1. Key up
2. Enter the SET MEMORY REPORT AFTER MEMORY SELECT function code
3. Unkey
4. The controller sends ENTER NEXT DATA indication
5. Enter a '1' to allow the memory report or a '0' to Not allow the memory report
6. Unkey
7. The controller sends the COMMAND ACCEPTED indication
8. If a '1' was entered the current remote base memory will be reported in morse code.

This function will allow you to enable or disable the memory number reporting after a remote base memory is selected. Entering a '1' enables the report after the remote base memory is selected and entering a '0' disables the report after a remote base memory is selected.

The default status (factory default) is the memory report will occur after the remote base memory is selected.

To keep the current setting of this function you must use the SAVE STATUSES command (command #87). This will insure the current status of this setting will be maintained upon power up and reset.

This feature is available starting with version 1.19 of the Linker II / Linker IIa software.

FUNCTION: PROGRAM TERMINATOR DIGIT

FUNCTION CODE: 131

PURPOSE: Allows the selection of the terminator digit

HOW TO USE:

1. Key up
2. Enter the PROGRAM TERMINATOR DIGIT function code
3. Unkey
4. The controller sends ENTER NEXT DATA indication
5. Enter the new terminator digit
6. Unkey
7. The controller sends the COMMAND ACCEPTED indication
8. The terminator digit is now stored. The controller will use new digit as the terminator.

This function is available starting with V1.21 of the Linker II and Linker IIa software.

FUNCTION: TERMINATOR CONTROL

FUNCTION CODE: 132

PURPOSE: This function enabling or disabling of the terminator..

HOW TO USE:

1. Key up
2. Enter the TERMINATOR CONTROL function code
3. Unkey
4. The controller sends ENTER NEXT DATA indication
5. Enter a '1' to enable the terminator or a '0' to disable the terminator
6. Unkey
7. The controller sends the COMMAND ACCEPTED indication
8. If a '1' was entered the terminator digit is now active..

This function will allow you to enable or disable the terminator. Entering a '1' enables the terminator and entering a '0' disables the terminator.

The default status (factory default) is the terminator is active in software versions before 1.30.1.

The default status (factory default) is the terminator is NOT active in software version 1.30.1 and later. This means the terminator must be enabled to use it in versions 1.30.1 and later.

To keep the current setting of this function you must use the SAVE STATUSES command (command #87). This will insure the current status of this setting will be maintained upon power up and reset.

This feature is available starting with version 1.21 of the Linker II / Linker IIa software.

FUNCTION: SET COURTESY TONE SPEED

FUNCTION CODE: 133

PURPOSE: This function is used for changing the courtesy tone speed..

HOW TO USE:

1. Key up
2. Enter the SET COURTESY TONE SPEED function code
3. Unkey
4. The controller sends ENTER NEXT DATA indication
5. Enter the desired courtesy tone speed in words per minute, 5wpm to 30wpm
6. Unkey
7. The controller sends the COMMAND ACCEPTED indication
8. The courtesy tone speed is now the newly entered value.

This feature is available starting with version 1.30 of the Linker II / Linker IIa software.

FUNCTION: ID CANCEL ENABLE

FUNCTION CODE: 134

PURPOSE: This function is used to enable ID canceling

HOW TO USE:

1. Key up
2. Enter the ID CANCEL ENABLE function code
3. Unkey
4. The controller sends the COMMAND ACCEPTED indication
5. The is now the newly entered value

The ID cancel will stop the ID anytime an enabled receiver is determined to be active. The controller will immediately try to ID again when there is not an enabled receiver active. When this is enabled the ID will not occur when the controller is activating the push to talk. In order for the IDer to stop trying to ID the full ID must be sent.

This feature is by default disabled.

To keep the current setting of this function you must use the SAVE STATUSES command (command #87). This will insure the current status of this setting will be maintained upon power up and reset.

This feature is available starting with version 1.30.1 of the Linker II / Linker IIa software.

FUNCTION: ID CANCEL DISABLE

FUNCTION CODE: 135

PURPOSE: This function is used to disable ID canceling

HOW TO USE:

1. Key up
2. Enter the ID CANCEL DISABLE function code
3. Unkey
4. The controller sends the COMMAND ACCEPTED indication
5. The courtesy tone speed is now the newly entered value

To keep the current setting of this function you must use the SAVE STATUSES command (command #87). This will insure the current status of this setting will be maintained upon power up and reset.

This feature is available starting with version 1.30.1 of the Linker II / Linker IIa software.

FUNCTION: TX2 ID WITH TX1 ENABLE

FUNCTION CODE: 136

PURPOSE: When this function is enabled TX2 will key up and ID anytime TX1 does

HOW TO USE:

1. Key up
2. Enter the TX2 ID WITH TX1 ENABLE function code
3. Unkey
4. The controller sends the COMMAND ACCEPTED indication
5. The courtesy tone speed is now the newly entered value

When this function is enabled TX2 will key up and ID anytime TX1 does. The jumper JP6 must be installed to have the cw audio sent to TX2.

This feature is by default disabled.

To keep the current setting of this function you must use the SAVE STATUSES command (command #87). This will insure the current status of this setting will be maintained upon power up and reset.

This feature is available starting with version 1.30.1 of the Linker II / Linker IIa software.

FUNCTION: TX2 ID WITH TX1 DISABLE

FUNCTION CODE: 137

PURPOSE: This function disables TX2 ID WITH TX1 ENABLE function

HOW TO USE:

1. Key up
2. Enter the ID CANCEL DISABLE function code
3. Unkey
4. The controller sends the COMMAND ACCEPTED indication
5. The courtesy tone speed is now the newly entered value

To keep the current setting of this function you must use the SAVE STATUSES command (command #87). This will insure the current status of this setting will be maintained upon power up and reset.

This feature is available starting with version 1.30.1 of the Linker II / Linker IIa software.

FUNCTION: ENABLE ANTIKERCHUNKER FILTER RX2

FUNCTION CODE: 138

PURPOSE Enables the rx2 Antikerchunker filter

HOW TO USE:

1. Key up
2. Enter the ENABLE ANTIKERCHUNKER FILTER RX2 function code
3. Unkey
4. The controller sends the COMMAND ACCEPTED indication
5. Now the rx2 Antikerchunker filter is enabled

To make this function permanent (Function stays active after power up or reset) the SAVE STATUSES function (function # 87) must be used.

This feature is available starting with version 1.31 of the Linker II / Linker IIa software.

FUNCTION: DISABLE ANTIKERCHUNKER FILTER RX2

FUNCTION CODE: 139

PURPOSE Disables the rx2 Antikerchunker filter

HOW TO USE:

1. Key up
2. Enter the DISABLE ANTIKERCHUNKER FILTER RX2 function code
3. Unkey
4. The controller sends the COMMAND ACCEPTED indication
5. Now the rx2 Antikerchunker filter is enabled

To make this function permanent (Function stays active after power up or reset) the SAVE STATUSES function (function # 87) must be used.

This feature is available starting with version 1.31 of the Linker II / Linker IIa software.

FUNCTION: SET ANTIKERCHUNKER FILTER DELAY RX2

FUNCTION CODE: 140

PURPOSE Allows changes to the rx2 Antikerchunker delay time

HOW TO USE:

1. Key up
2. Enter the SET ANTIKERCHUNKER FILTER DELAY RX2 function code
3. Unkey
4. The controller sends the ENTER NEXT DATA indication
5. Key up
6. Enter the time in seconds
7. Unkey
8. The controller sends the COMMAND ACCEPTED indication
9. Now the rx2 Antikerchunker filter is set to the entered value

The range of the delay timer is 0.1s to 25s. This timer sets the amount of time the receiver needs to be active before the antikerchunker filter stops filtering. Use the '*' key for the decimal point. You may enter up to 4 digits (the decimal point counts as a digit).

This feature is available starting with version 1.31 of the Linker II / Linker IIa software.

FUNCTION: SET ANTIKERCHUNKER FILTER INTERVAL TIME RX2

FUNCTION CODE: 141

PURPOSE: Allows changes to the interval timer - the time before the Linker IIa restarts the rx2 Antikerchunker filter

HOW TO USE:

1. Key up
2. Enter the SET ANTIKERCHUNKER FILTER INTERVAL TIME RX2 function code
3. Unkey
4. The controller sends the ENTER NEXT DATA indication
5. Key up
6. Enter the time in seconds
7. Unkey
8. The controller sends the COMMAND ACCEPTED indication
9. Now the rx2 Antikerchunker filter interval time is set to the entered value

The range of the interval timer is 10s to 2500 seconds. This timer starts after the rx2 antikerchunker times out. When this timer times out the rx2 antikerchunker filter is again started.

This feature is available starting with version 1.31 of the Linker II / Linker IIa software.

FUNCTION: ENABLE RX1 TONE RX2 ACTIVE

FUNCTION CODE: 142

PURPOSE This function will allow a rx1 courtesy tone even with rx2 cos active

HOW TO USE:

1. Key up
2. Enter the ENABLE RX1 TONE RX2 ACTIVE function code
3. Unkey
4. The controller sends the COMMAND ACCEPTED indication
5. Now the rx1 courtesy tone will occur even if rx2 is active

This function, when enabled, will allow the courtesy tone from rx1 to occur when the rx1 cos becomes non-active and the rx2 cos is still active.

To make this function permanent (Function stays active after power up or reset) the SAVE STATUSES function (function # 87) must be used.

This feature is available starting with version 1.32 of the Linker II / Linker IIa software.

FUNCTION: DISABLE RX1 TONE RX2 ACTIVE

FUNCTION CODE: 143

PURPOSE: This disables the rx1 courtesy tone when rx2 is active

HOW TO USE:

1. Key up
2. Enter the DISABLE RX1 TONE RX2 ACTIVE function code
3. Unkey
4. The controller sends the COMMAND ACCEPTED indication
5. The controller will not send the rx1 courtesy tone when rx2 is active

To make this function permanent (Function stays active after power up or reset) the SAVE STATUSES function (function # 87) must be used.

This feature is available starting with version 1.32 of the Linker II / Linker IIa software

FUNCTION: NO ID WHEN PORT 2 ENABLED ON

FUNCTION CODE: 144

PURPOSE: If this function is active the IDer will be disabled when port 2 is on.

HOW TO USE:

1. Key up
2. Enter the NO ID WHEN PORT2 ENABLED ON function code
3. Unkey
4. The controller sends the COMMAND ACCEPTED indication
5. The controller will not ID when port 2 is active

To make this function permanent (function stays active after power up or reset) the SAVE STATUSES function (function # 87) must be used.

This feature is available starting with version 1.33 of the Linker II / Linker IIa software

FUNCTION: NO ID WHEN PORT2 ENABLED OFF

FUNCTION CODE: 145

PURPOSE: This disables the “no ID when port 2 is enabled” function

HOW TO USE:

1. Key up
2. Enter the NO ID WHEN PORT2 ENABLED OFF function code
3. Unkey
4. The controller sends the COMMAND ACCEPTED indication
5. The controller will now send the ID normally

To make this function permanent (function stays active after power up or reset) the SAVE STATUSES function (function # 87) must be used.

This feature is available starting with version 1.33 of the Linker II / Linker IIa software

FUNCTION: DISABLE RX2 TX1 AND TX2

FUNCTION CODE: 146

PURPOSE: This disables the controller by disabling RX2, TX1 and TX2

HOW TO USE:

1. Key up
2. Enter the DISABLE RX2 TX1 AND TX2 function code
3. Unkey
4. The controller sends the COMMAND ACCEPTED indication
5. Now RX2, TX1 and TX2 will be disabled.

To make this function permanent (function stays active after power up or reset) the SAVE STATUSES function (function # 87) must be used.

This feature is available starting with version 1.33 of the Linker II / Linker IIa software

FUNCTION: ENABLE RX2 TX1 AND TX2

FUNCTION CODE: 147

PURPOSE: This enables RX2, TX1 and TX2

HOW TO USE:

1. Key up
2. Enter the ENABLE RX2 TX1 AND TX2 function code
3. Unkey
4. The controller sends the COMMAND ACCEPTED indication
5. RX2, TX1 and TX2 are now enabled.

To make this function permanent (function stays active after power up or reset) the SAVE STATUSES function (function # 87) must be used.

This feature is available starting with version 1.33 of the Linker II / Linker IIa software.

FUNCTION: SEND RESPONSE TO TX1 IN XPEAT ENABLE

FUNCTION CODE: 148

PURPOSE: If in xpeat mode this enables the sending of all function responses to TX1

HOW TO USE:

1. Key up
2. Enter the SEND RESPONSE TO TX1 IN XPEAT ENABLE function code
3. Unkey
4. The controller sends the COMMAND ACCEPTED indication
5. The controller in xpeat mode will now send the function responses to TX1 instead of TX2

To make this function permanent (function stays active after power up or reset) the SAVE STATUSES function (function # 87) must be used.

This feature is available starting with version 1.33 of the Linker II / Linker IIa software.

FUNCTION: SEND RESPONSE TO TX1 IN XPEAT DISABLE

FUNCTION CODE: 149

PURPOSE: If in xpeat mode this disables the sending of all function responses to TX1

HOW TO USE:

1. Key up
2. Enter the SEND RESPONSE TO TX1 IN XPEAT DISABLE function code
3. Unkey
4. The controller sends the COMMAND ACCEPTED indication
5. The controller will not send the rx1 courtesy tone when rx2 is active

To make this function permanent (function stays active after power up or reset) the SAVE STATUSES function (function # 87) must be used.

The controller in xpeat mode will now send the function responses to TX2.

This feature is available starting with version 1.33 of the Linker II / Linker IIa software.

FUNCTION: SET HANG TIME TX2

FUNCTION CODE: 150

PURPOSE: Sets the time TX 2 is on after the receiver(s) become inactive.

HOW TO USE:

1. Key up
2. Enter the SET HANG TIME TX2 code
3. Unkey
4. The controller sends the ENTER NEXT DATA code
5. Key up
6. Enter the hang time in seconds
7. Unkey
8. The controller sends the COMMAND ACCEPTED indication
9. The new hang time value is stored

The range of the timer is from 0 seconds to 25 seconds. If a value is entered outside these limits the controller will not save the entered value, it will give the ERROR or BAD VALUE indication (B in CW) and the function will be ended. The timer is accurate to about 0.1 second.

To enter a decimal point use the ' * ' key. To enter the value 1.2 sec enter ' 1*2 ' on your DTMF keypad.

This feature is available starting with version 1.33 of the Linker II / Linker IIa software.

FUNCTION: PULSE TX2 OFF ON ENABLE

FUNCTION CODE: 151

PURPOSE: Will pulse TX2 off and on when TX2 hang time starts

HOW TO USE:

1. Key up
2. Enter the PULSE TX2 OFF ON ENABLE function code
3. Unkey
4. The controller sends the COMMAND ACCEPTED indication
5. The controller will pulse TX2 off and on when the TX2 hang time starts

To make this function permanent (function stays active after power up or reset) the SAVE STATUSES function (function # 87) must be used.

There is a timer for this function (see Function 153). The timer can be set from 0.004s to 1.000s.

This feature is available starting with version 1.34 of the Linker II / Linker IIa software.

FUNCTION: PULSE TX2 OFF ON DISABLE

FUNCTION CODE: 152

PURPOSE: Disables Pulse TX2 off / on.

HOW TO USE:

1. Key up
2. Enter the PULSE TX2 OFF ON ENABLE function code
3. Unkey
4. The controller sends the COMMAND ACCEPTED indication
5. TX2 will operate normally

To make this function permanent (function stays active after power up or reset) the SAVE STATUSES function (function # 87) must be used.

This feature is available starting with version 1.34 of the Linker II / Linker IIa software.

FUNCTION: SET TX2 OFF ON TIMER
FUNCTION CODE: 153
PURPOSE: Sets the time too pulse TX2 off

HOW TO USE:

1. Key up
2. Enter the SET TX2 OFF ON TIMER code
3. Unkey
4. The controller sends the ENTER NEXT DATA code
5. Key up
6. Enter the off pulse time in seconds
7. Unkey
8. The controller sends the COMMAND ACCEPTED indication
9. The new TX2 off/on time value is stored

The range of the timer is from 0.004 second to 1 second. If a value is entered outside these limits the controller will not save the entered value, it will give the ERROR or BAD VALUE indication (B in CW) and the function will be ended. The timer is accurate to about 0.004 second.

To enter a decimal point use the '*' key. To enter the value .12 sec enter '*12' on your DTMF keypad.

This feature is available starting with version 1.34 of the Linker II / Linker IIa software.

FUNCTION: ENABLE RX1
FUNCTION CODE: 154
PURPOSE: Sets the time TX 2 is on after the receiver(s) become inactive.

HOW TO USE:

1. Key up
2. Enter the ENABLE RX1 function code
3. Unkey
4. The controller sends the COMMAND ACCEPTED indication
5. RX1 will be enabled

To make this function permanent (function stays active after power up or reset) the SAVE STATUSES function (function # 87) must be used.

This feature is available starting with version 1.34 of the Linker II / Linker IIa software.

FUNCTION: DISABLE RX1

FUNCTION CODE: 155

PURPOSE: RX1 will not respond to it's COS or CTCSS inputs

HOW TO USE:

1. Key up
2. Enter the DISABLE RX1 function code
3. Unkey
4. The controller sends the COMMAND ACCEPTED indication
5. The controller will not respond to RX1's inputs

To make this function permanent (function stays active after power up or reset) the SAVE STATUSES function (function # 87) must be used.

This feature is available starting with version 1.34 of the Linker II / Linker IIa software.

FUNCTION: PROGRAM ID DELAY TIMER

FUNCTION CODE: 156

PURPOSE: This function will set the time for the delay between the time the controllers plans to ID and when the ID is actually started. This is typically after the COS's are inactive

HOW TO USE:

1. Key up
2. Enter the PROGRAM ID DELAY TIMER Function code
3. Unkey
4. The controller sends the ENTER NEXT DATA code
5. Key up
6. Enter the delay time in seconds
7. Unkey
8. The controller sends the COMMAND ACCEPTED indication
9. The new delay time value is stored

This feature is available starting with version 1.35 of the Linker II / Linker IIa software.

FUNCTION: PROGRAM RX1 HANG TIME TX1

FUNCTION CODE: 157

PURPOSE: This function will set the RX1 hang time.

HOW TO USE:

1. Key up
2. Enter the PROGRAM RX1 HANG TIME TX1 Function code
3. Unkey
4. The controller sends the ENTER NEXT DATA code
5. Key up
6. Enter the hang time in seconds
7. Unkey
8. The controller sends the COMMAND ACCEPTED indication
9. The new hang time value is stored

This function will program the hang time used for RX1. This RX1 hang time will request TX1 stays on for the delay time after the RX1 COS drops. If this function is set to zero it will have no effect on TX1.

This feature is available starting with version 1.36 of the Linker II / Linker IIa software.

FUNCTION: PROGRAM RX2 HANG TIME TX1

FUNCTION CODE: 158

PURPOSE: This function will set the RX2 hang time

HOW TO USE:

1. Key up
2. Enter the PROGRAM RX2 HANG TIME TX1 Function code
3. Unkey
4. The controller sends the ENTER NEXT DATA code
5. Key up
6. Enter the hang time in seconds
7. Unkey
8. The controller sends the COMMAND ACCEPTED indication
9. The new hang time value is stored

This function will program the hang time used for RX2. This RX2 hang time will request TX1 stays on for the delay time after the RX1 COS drops. If this function is set to zero it will have no effect on TX1.

This feature is available starting with version 1.36 of the Linker II / Linker IIa software.

FUNCTION: TX1 ON FOR ID DELAY

FUNCTION CODE: 159

PURPOSE: The transmitter will be on when the ID delay timer is active

HOW TO USE:

1. Key up
2. Enter the TX1 ON FOR ID DELAY function code
3. Unkey
4. The controller sends the COMMAND ACCEPTED indication
5. The transmitter will be on when the ID delay timer is running

To make this function permanent (function stays active after power up or reset) the SAVE STATUSES function (function # 87) must be used.

This feature is available starting with version 1.36 of the Linker II / Linker IIa software.

FUNCTION: TX1 OFF FOR ID DELAY

FUNCTION CODE: 160

PURPOSE: The transmitter will not be turned on by the ID'er when the ID delay timer is active

HOW TO USE:

1. Key up
2. Enter the TX1 ON FOR ID DELAY function code
3. Unkey
4. The controller sends the COMMAND ACCEPTED indication
5. The transmitter will not be on when the ID delay timer is running

To make this function permanent (function stays active after power up or reset) the SAVE STATUSES function (function # 87) must be used.

This feature is available starting with version 1.36 of the Linker II / Linker IIa software.

FUNCTION: TX2 ON FOR ID DELAY

FUNCTION CODE: 161

PURPOSE: The transmitter will be on when the ID delay timer is active

HOW TO USE:

1. Key up
2. Enter the TX2 ON FOR ID DELAY function code
3. Unkey
4. The controller sends the COMMAND ACCEPTED indication
5. The transmitter will be on when the ID delay timer is running

To make this function permanent (function stays active after power up or reset) the SAVE STATUSES function (function # 87) must be used.

This feature is available starting with version 1.37 of the Linker II / Linker IIa software.

FUNCTION: TX2 OFF FOR ID DELAY

FUNCTION CODE: 162

PURPOSE: The transmitter will not be turned on by the ID'er when the ID delay timer is active

HOW TO USE:

1. Key up
2. Enter the TX2 ON FOR ID DELAY function code
3. Unkey
4. The controller sends the COMMAND ACCEPTED indication
5. The transmitter will not be on when the ID delay timer is running

To make this function permanent (function stays active after power up or reset) the SAVE STATUSES function (function # 87) must be used.

This feature is available starting with version 1.37 of the Linker II / Linker IIa software.

FUNCTION: TX1 OFF FOR DTMF DISABLE

FUNCTION CODE: 163

PURPOSE: Disables the TX1 DTMF mute function

HOW TO USE:

1. Key up
2. Enter the TX1 OFF FOR DTMF DISABLE function code
3. Unkey
4. The controller sends the COMMAND ACCEPTED indication
5. The transmitter will operate normally

To make this function permanent (function stays active after power up or reset) the SAVE STATUSES function (function # 87) must be used.

This feature is available starting with version 1.37 of the Linker II / Linker IIa software.

FUNCTION: TX1 OFF FOR DTMF ENABLE

FUNCTION CODE: 164

PURPOSE: Turns off the transmitter will be turned off when a DTMF tone is heard

HOW TO USE:

1. Key up
2. Enter the TX1 OFF FOR DTMF ENABLE function code
3. Unkey
4. The controller sends the COMMAND ACCEPTED indication
5. The transmitter will go off when a DTMF tone is heard

To make this function permanent (function stays active after power up or reset) the SAVE STATUSES function (function # 87) must be used.

This feature is available starting with version 1.37 of the Linker II / Linker IIa software.

PROGRAMMABLE TONES AND AVAILABLE TONES

1. Programmable tones (See function #127)

A. Port 1 programmable tone	0
B. Port 2 programmable tone	1
C. Setup mode programmable tone	2
D. Change memory programmable tone	3
E.. Port 1 programmable tone when Port 2 is active	4

2. Available Morse code tones

Zero	0
One	1
Two	2
Three	3
Four	4
Five	5
Six	6
Seven	7
Eight	8
Nine	9
A	10
B	11
C	12
D	13
E	14
F	15
G	16
H	17
I	18
J	19
K	20
L	21
M	22
N	23
O	24
P	25
Q	26
R	27
S	28
T	29
U	30
V	31
W	32
X	33
Y	34
Z	35
Slash	36
Empty (no tone)	37
K	38
Beep	39

REPEATER CONTROL CODES				
Memory #	DTMF Codes	Control Op ?	Function code	Function Description
0				
1				
2				
3				
4				
5				
6				
7				
8				
9				
10				
11				
12				
13				
14				
15				
16				
17				
18				
19				
20				
21				
22				
23				
24				